



The **WISE** Choice

## EASTMAN WORLD

---

Welcome to Eastman World - Your Global Partner in Energy Solutions!



## SOLAR SOLUTIONS

---

SOLAR INVERTERS | SOLAR CHARGE CONTROLLERS  
SOLAR PUMP INVERTERS | SOLAR PANELS

# Eastman Introduction

**Founded in 2006**

Established in 2006, Eastman Auto & Power Limited is a well-known name in the field of solar energy, energy storage, and power electronics, boasting a USD 300 million revenue and a dedicated workforce of over 3,000 professionals. Building on the group's decades-long success and maintaining the trust of our partners, Mr. Jagdish Rai Singal ventured into the future of energy with Eastman Auto & Power Limited. Today, the business spans over 25 countries across Asia and Africa, providing the world with cutting-edge products that have set new benchmarks in their respective segments. Driven by innovation, we continually set industry standards, ensuring uninterrupted power supply for residential, commercial, and industrial applications.

Our global solar distribution business provides reliable and high-quality solar solutions, including solar inverters, solar panels, solar batteries (tubular, carbon, gel and lithium) solar pump inverters, solar charge controllers, and more. Our products offer a range of solutions to help you make the switch to clean energy. With us as your unwavering partners, we forge a sustainable future, amplifying global excellence through transformative products and services.





# CONTENT

EXPLORE OUR CATALOGUE FOR TOP-QUALITY ENERGY STORAGE AND SOLAR SOLUTIONS DESIGNED TO MEET YOUR NEEDS.

**SOLAR INVERTERS** **04**

---

**SOLAR CHARGE CONTROLLER** **16**

---

**SOLAR PUMP INVERTER** **26**

---

**SOLAR PANELS** **29**

---



# **SOLAR INVERTERS**

**OFF GRID INVERTERS**

**HYBRID INVERTERS**





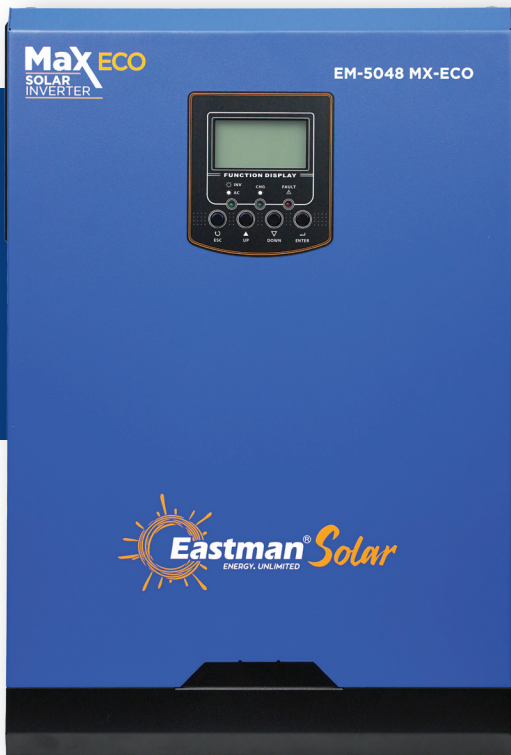

# MAX ECO OFF-GRID INVERTER 1200W/ 3000W / 5000W

## Introduction

Eastman Max Eco Off-grid Inverter an innovative solution designed to power your off-grid adventures with reliability and efficiency. With cutting-edge technology and a commitment to sustainability, the Max Eco Off-grid Inverter provides a reliable energy source, enabling you to adopt off-grid living without making concessions.

## Product Features

- Pure sine wave solar inverter.
- Reserved communication port for BMS.
- Wide PV input range.
- Battery independent design.
- Maximum charging current 100A.
- Battery equalization function to optimize battery performance and extend life cycle.
- Built-in anti-dust kit.

## Applications

Hospitality, Schools, Universities, Poultry, Agri & Cold Storage, Corporate and Residential.

## Connection Diagram

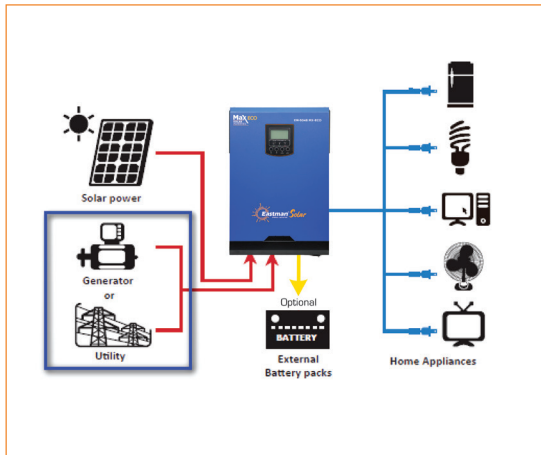

## Key Features

MODEL	EM-1212 MX-ECO	EM-3024 MX-ECO	EM-5048 MX-ECO
Power Factor	1	1	1
Max PV Array	2000 W	3000 W	5000 W
MPPT Range	60-300VDC	60-400VDC	120-450VDC
Lithium Compatibility	No	Yes	Yes
Parallel Function	No	No	No
Detachable Screen	No	No	No
Wifi	Optional	Optional	Optional
Battery Voltage	12 VDC	24 VDC	48 VDC
Solar Charging Current	100 A	100 A	100 A
Dimension D*W*H (mm)	90*288*357	110*288*390	120*300*440
Net Weight (Kgs)	6.5	7.5	10
Operating Temperature	-10°C to 50°C	-10°C to 50°C	-10°C to 50°C

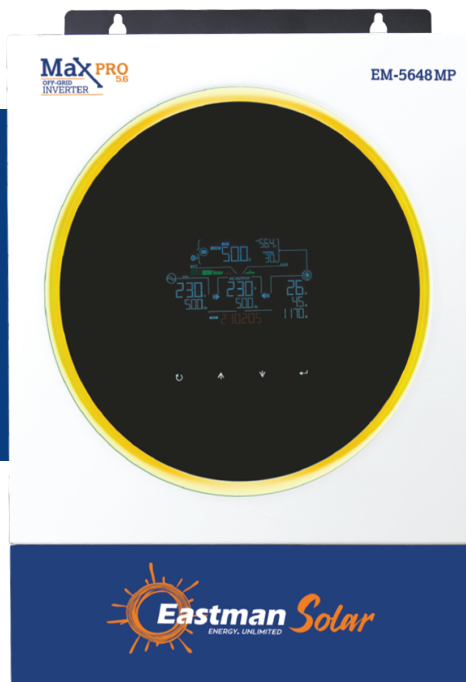

# MAX PRO OFF-GRID INVERTER 6000W

## Introduction

Eastman Max Pro Off-grid Inverter an advanced power solution crafted for off-grid living and energy independence. With its state-of-the-art design and superior performance, the Eastman Max Pro ensures a robust power supply, allowing you to enjoy the comforts of modern living while off the traditional grid.



## Product Features

- Customizable status LED ring with RGB lights Touchable button with 4.3" colored LCD.
- Built-in Wifi for mobile monitoring (Android & IOS App is available).
- Supports USB On-the-Go function.
- Reserved communication port for BMS.
- Battery independent design.
- Battery equalization extends lifecycle.
- User-friendly LCD operation.
- Enhanced charging power.
- Built-in-anti-dust kit.

## Connection Diagram

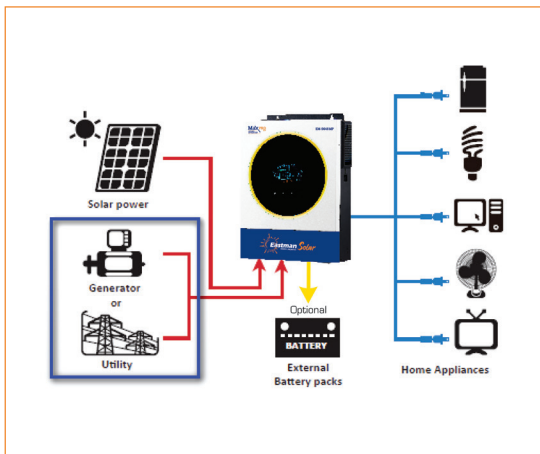

## Applications

Hospitality, Schools, Universities, Poultry, Agri & Cold Storage, Corporate and Residential.

## Key Features

MODEL	EM-5648 MP
Power Factor	1
Max PV Array	6000 W
MPPT Range	120-450 VDC
Lithium Compatibility	Yes
Parallel Function	No
Detachable Screen	No
Wifi	Yes
Battery Voltage	48 VDC
Solar Charging Current	120 A
Dimension D*W*H (mm)	119*313.6*422.8
Net Weight (Kgs)	12.0
Operating Temperature	-10°C to 50°C





# MAX TWIN OFF-GRID INVERTER 4000W / 6000W

## Introduction

Eastman Max Twin Inverter is designed with a dual-inverter system, ensuring enhanced efficiency and reliability for off-grid setups. It combines advanced technology with robust performance, providing a dependable energy source for a variety of off-grid applications, delivering consistent and stable power wherever your adventures take you.

## Product Features

- Dual output for smart load management Maximum PV input current 27A.
- Wide PV input voltage range 60VDC-450VDC Customizable status LED ring with RGB lights.
- Touchable button with large 4.3" colored LCD.
- Built-in Wifi for mobile monitoring (Android/iOS App available).
- Supports USB On-the-Go function.
- Data log event stored in the inverter.
- Reserved communication port (RS485, CAN-BUS or RS232) for BMS.
- Battery independent design.
- Battery equalization extends lifecycle.
- Enhanced charging power.
- Built-in anti-dust kit.

## Connection Diagram

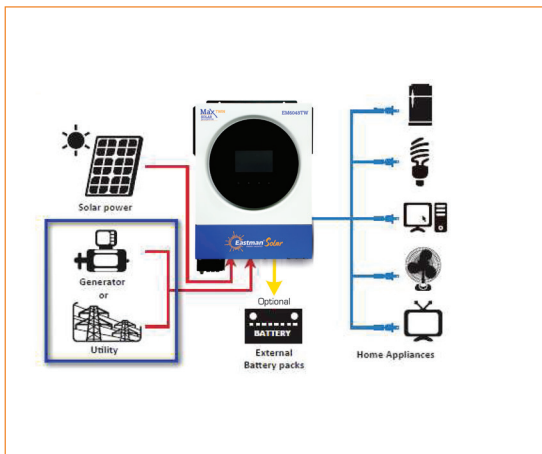

## Key Features

MODEL	EM4024TW	EM6048TW
Power Factor	1	1
Max PV Array	5000 W	6000 W
MPPT Range	60-450VDC	60-450VDC
Lithium Compatibility	Yes	Yes
Parallel Function	No	No
Detachable Screen	No	No
Wifi	Yes	Yes
Battery Voltage	24 VDC	48 VDC
Solar Charging Current	120 A	120 A
Dimension D*W*H (mm)	119*313.6*475.5	119*313.6*475.5
Net Weight (Kgs)	10	12
Operating Temperature	-10°C to 50°C	-10°C to 50°C

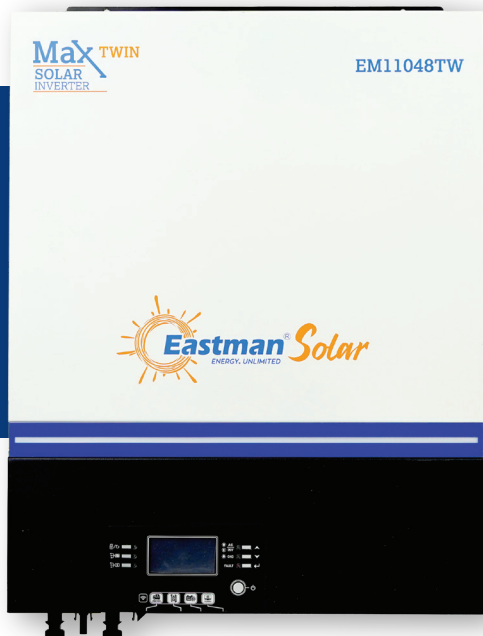

# MAX TWIN OFF-GRID INVERTER 8000W / 11000W

## Introduction

Eastman Max Twin Inverter is designed with a dual-inverter system, ensuring enhanced efficiency and reliability for off-grid setups. It combines advanced technology with robust performance, providing a dependable energy source for a variety of off-grid applications, delivering consistent and stable power wherever your adventures take you.



## Product Features

- Dual outputs, for smart load management.
- Maximum PV input current increases to 27A.
- Wide PV input voltage range 90VDC - 450VDC.
- Status indication with RGB lights.
- Built-in Wi-Fi for mobile monitoring (Android/iOS App is available).
- Supports USB On-the-Go function.
- Reserved communication port for BMS (RS485, CAN-BUS or RS232) Replaceable fan design for ease of maintenance.
- Battery independent design.
- Selectable high power charging current.
- Compatible to Utility Mains or generator input.
- Built-in anti-dust kit.
- Parallel operation with 6 units.

## Connection Diagram

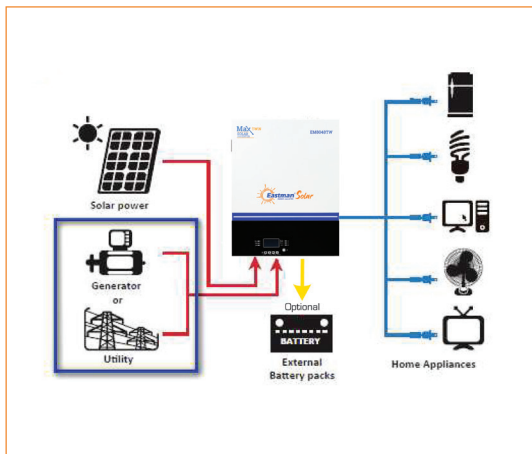

## Key Features

MODEL	EM8048TW	EM11048TW
Power Factor	1	1
Max PV Array	8000 W	11000 W
MPPT Range	90-450 VDC	90-450 VDC
Lithium Compatibility	Yes	Yes
Parallel Function	Yes, Up to 6 Units	Yes, Up to 6 Units
Detachable Screen	No	No
Wifi	Yes	Yes
Battery Voltage	48 VDC	48 VDC
Solar Charging Current	120 A	150 A
Dimension D*W*H (mm)	147.4*432.5*553.6	147.4*432.5*553.6
Net Weight (Kgs)	18.4	18.4
Operating Temperature	-10°C to 50°C	-10°C to 50°C





# SOL1 ECO OFF-GRID INVERTER 3200W / 5500W

## Introduction

Eastman SOL1 Eco Off-grid Inverter—a smart solution tailored for off-grid energy needs. It offers seamless integration with solar panels, efficiently converting solar energy into reliable electricity. With its user-friendly design and built-in MPPT technology, this inverter ensures a hassle-free experience, providing consistent and sustainable power.

## Product Features

- Pure sine wave MPPT solar inverter.
- Built-in 80/100A MPPT solar charger.
- Battery equalization function extend lifecycle
- Reserved communication port(RS485,CAN)for BMS.
- SOL1-ECO series is suitable for
- Easy access: High PV input voltage range With touch buttons.

## Applications

Hospitality, Schools, Universities, Poultry, Agri & Cold Storage, Corporate and Residential.

## Connection Diagram

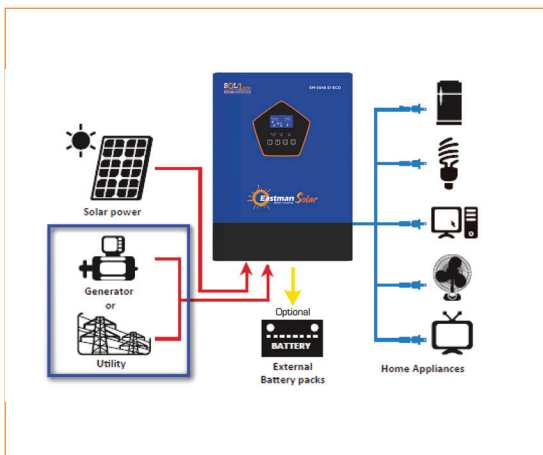

## Key Features

MODEL	EM-3224 S1-ECO	EM-5548 S1-ECO
Power Factor	1	1
Max PV Array	3500 W	5500 W
MPPT Range	60-450VDC	60-450VDC
Lithium Compatibility	Yes	Yes
Parallel Function	No	No
Detachable Screen	No	No
Wifi	Optional	Optional
Battery Voltage	24 VDC	48 VDC
Solar Charging Current	120 A	120 A
Dimension D*W*H (mm)	335*225*105	400*300*115
Net Weight (Kgs)	6	9.5
Operating Temperature	-10°C to 50°C	-10°C to 50°C

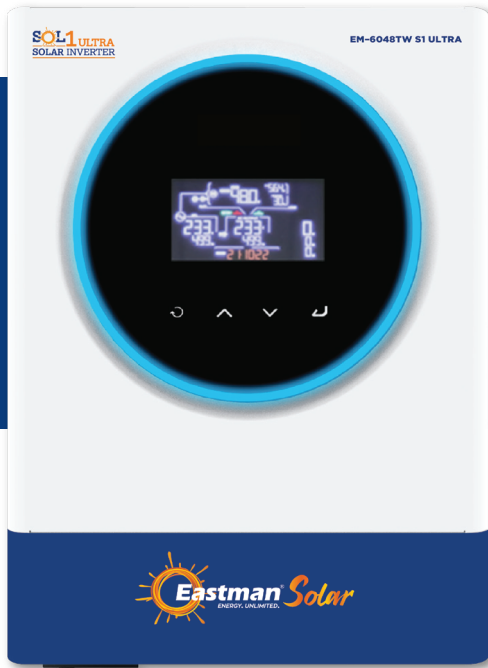

# SOL1 ULTRA TWIN OFF-GRID INVERTER 4000W / 6000W



## Introduction

Eastman SOL1 ULTRA Off-grid Inverter - Featuring a battery independence design, this advanced inverter ensures optimal energy management and versatility. The Eastman SOL 1 allows seamless operation even without batteries, maximizing solar energy usage for various off grid applications.

## Product Features

- Designed with 27A PV input current compatible to the market trend of increased Imp of solar panel.
- Battery equalization function extend lifecycle Reserved communication port(RS485,CAN)for BMS.
- Two outputs for smart load management The second output can be scheduled on & off based on setting point of battery transfer to utility.
- Global cloud platform mobile APP anytime and anywhere open APP, support power internet applications.
- SOL1 ULTRA series is suitable for off-grid applications.
- Customizable status LED ring with RGB lights.

## Connection Diagram

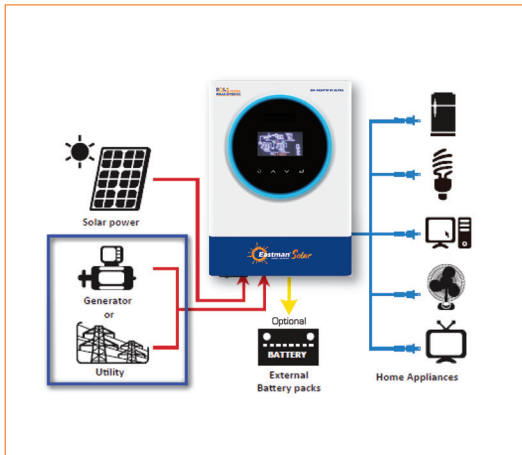

## Key Features

MODEL	EM-4024TW S1 ULTRA	EM-6048TW S1 ULTRA
Power Factor	1	1
Max PV Array	4000 W	6000 W
MPPT Range	60-450VDC	60-450VDC
Lithium Compatibility	Yes	Yes
Parallel Function	No	No
Detachable Screen	No	No
Wifi	Optional	Optional
Battery Voltage	24 VDC	48 VDC
Solar Charging Current	120 A	120 A
Dimension D*W*H (mm)	434*311*126.5	434*311*126.5
Net Weight (Kgs)	8.5	9
Operating Temperature	0°C to 50°C	0°C to 50°C



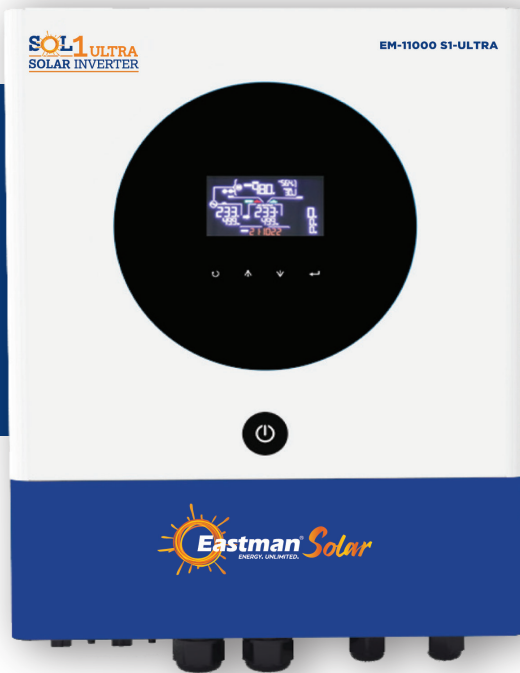

# SOL1 ULTRA OFF-GRID INVERTER 8000W / 11000W



## Introduction

Eastman SOL1 ULTRA Off-grid Inverter - Featuring a battery independence design, this advanced inverter ensures optimal energy management and versatility. The Eastman SOL 1 allows seamless operation even without batteries, maximizing solar energy usage for various off grid applications.

## Product Features

- Status indication with RGB lights.
- Built-in Wi-Fi for mobile monitoring (Android/iOS App is available).
- Reserved communication port for BMS.
- Replaceable fan design for ease of maintenance.
- Battery independent design.
- Configurable AC/PV output usage timer and prioritization.
- Selectable high power charging current.
- Selectable input voltage range for home appliances and personal computers.
- Compatible to Utility Mains or generator input.
- Parallel operation with 6 units.
- Supports USB On-the-Go function.
- Built-in anti-dust kit.

## Connection Diagram

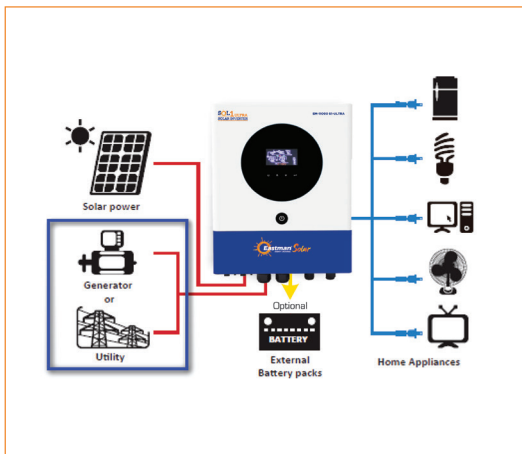

## Key Features

MODEL	EM8000-S1-ULTRA	EM11000-S1-ULTRA
Power Factor	1	1
Max PV Array	8000 W	11000 W
MPPT Range	90-450VDC	90-450VDC
Lithium Compatibility	Yes	Yes
Parallel Function	Yes, Up to 6 Units	Yes, Up to 6 Units
Detachable Screen	No	No
Wifi	Yes	Yes
Battery Voltage	24 VDC	48 VDC
Solar Charging Current	120 A	150 A
Dimension D*W*H (mm)	147.4*432.5*553.6	152.4*420*561.6
Net Weight (Kgs)	18	18
Operating Temperature	-10°C to 50°C	-10°C to 50°C



# HYBRID INVERTER SINGLE PHASE 3 & 3.6kW

## Introduction

The Eastman low voltage Series storage Inverters are designed to increase energy independence for homeowners. The power range is from 3kW to 3.6kW, compatible with low voltage (40-60V) batteries.

Energy management is based on time-of-use and demand charge rate structures, significantly reduce the amount of energy purchased from the public grid.

Thanks for the UPS function (switch time < 10ms), enables the crucial loads power on during outages. Additionally, under the backup operation mode, the inverter provides you up to 150% peak output overloading. The Eastman low voltage Series storage inverters integrated with Arc Fault Circuit Interrupter (AFCI) and Rapid Shutdown.

## Connection Diagram

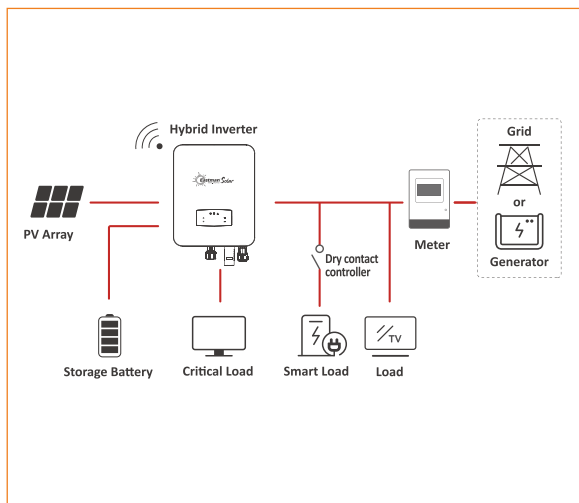

## Product Features

- 1.5 Times PV Oversize
- Up to 2 MPPT Channels
- UPS Function Switch Time < 10ms
- Max.6 Parallel Stacking
- Input Support Generator
- Support for Time-of-use Optimization
- Build in Anti-feed- in Function
- Configurable Operation Modes
- Compact Size and Easy Installation
- Arc Fault Circuit Interrupter (AFCI) (Optional)
- Smart Monitoring & Remote Firmware Upgrade

## Product Specifications

MODEL	ES3KW-SL-HY	ES3.6KW-SL-HY
Nominal Inverter Power (kW)	3kW	3.6kW
Max. DC Input Power (kW)	4.5	5.4
Max. PV Voltage (V)	550	
MPPT Voltage Range (V)	80 - 500	
Normal Voltage (V)	360	
Startup Voltage (V)	100	
Max. Input Current (A)	18.5 x 2	
Max. Short Current (A)	26 x 2	
No. of MPPT Tracker / No. of PV String	2/2	
Max. Charge/Discharge Power (kW)	3.0	3.6
Max. Charge/Discharge Current (A)	80	
Battery Normal Voltage	51.2	
Net Weight (Kgs)	26.5	
Dimensions (W x H x D, mm)	370 x 535 x 192	
Warranty	5 Years	



# HYBRID INVERTER THREE PHASE

## 3 ~ 12kW



### Introduction

The Eastman three phase storage inverters are designed to increase energy independence for homeowners and commercial users. The power range is from 3.0kW to 30kW, compatible with high voltage (150-800V) batteries.

Energy management is based on time-of-use and demand charge rate structures, significantly reduce the amount of energy purchased from public grid.

Thanks for the UPS function (switch time < 10ms), enables the crucial loads power on during outages. Additionally, under the backup operation mode, the inverter provides you up to 150% peak output overloading.

### Connection Diagram

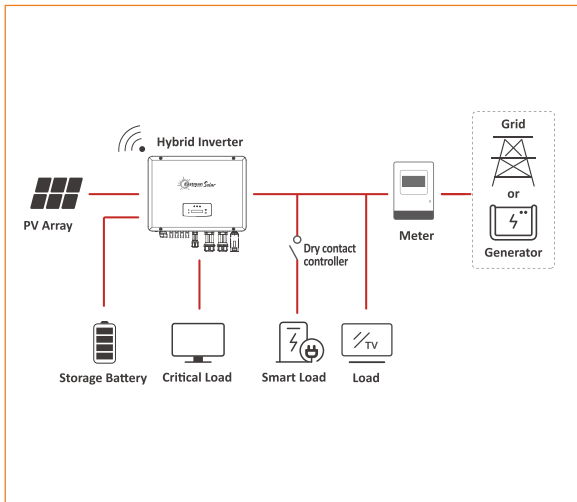

### Product Features

- Support Sodium-ion Battery
- 150-800V Voltage Range
- 100% Support Unbalance Load
- 1.5 Times PV Oversize
- Max.String Current Up To 20A
- Support for Time-of-use Optimization
- Build in Anti-feed- in Function
- Configurable Operation Modes
- Compact Size and Easy Installation
- Arc Fault Circuit Interrupter (AFCI) (Optional)
- Smart Monitoring & Remote Firmware Upgrade

### Product Specifications

MODEL	ES3KW-TH-HY	ES4KW-TH-HY	ES5KW-TH-HY	ES6KW-TH-HY	ES8KW-TH-HY	ES10KW-TH-HY	ES12KW-TH-HY
Nominal Inverter Power (kW)	3kW	4kW	5kW	6kW	8kW	10kW	12kW
Max. DC Input Power (kW)	5	6	7.5	9	12	15	18
Max. PV Voltage (V)	1000						
MPPT Voltage Range (V)	150 - 850						
Rated DC Input Voltage (V)	620						
Startup Voltage (V)	160						
Max. DC Input Current (A)	20 x 2						
Max. Short Current (A)	30 x 2						
No. of MPPT Tracker / String	2/2						
Max. Charge/Discharge Power (kW)	3	4	5	6	8	10	12
Max. Charge/Discharge Current (A)	30						
Battery Normal Voltage (V)	200	200	200	250	300	400	450
Net Weight (Kgs)	20.8						
Dimensions (W x H x D, mm)	370 x 497 x 192						
Warranty	5 Years						





# HYBRID INVERTER THREE PHASE 15 ~ 30kW

## Introduction

The Eastman three phase storage inverters are designed to increase energy independence for homeowners and commercial users. The power range is from 3.0kW to 30kW, compatible with high voltage (150-800V) batteries.

Energy management is based on time-of-use and demand charge rate structures, significantly reduce the amount of energy purchased from public grid.

Thanks for the UPS function (switch time < 10ms), enables the crucial loads power on during outages. Additionally, under the backup operation mode, the inverter provides you up to 150% peak output overloading.

## Product Features

- Support Sodium-ion Battery
- 150-800V Voltage Range
- 100% Support Unbalance Load
- 1.5 Times PV Oversize
- Max.String Current Up To 40A
- Support for Time-of-use Optimization
- Build in Anti-feed- in Function
- Configurable Operation Modes
- Compact Size and Easy Installation
- Arc Fault Circuit Interrupter (AFCI) (Optional)
- Smart Monitoring & Remote Firmware Upgrade

## Connection Diagram

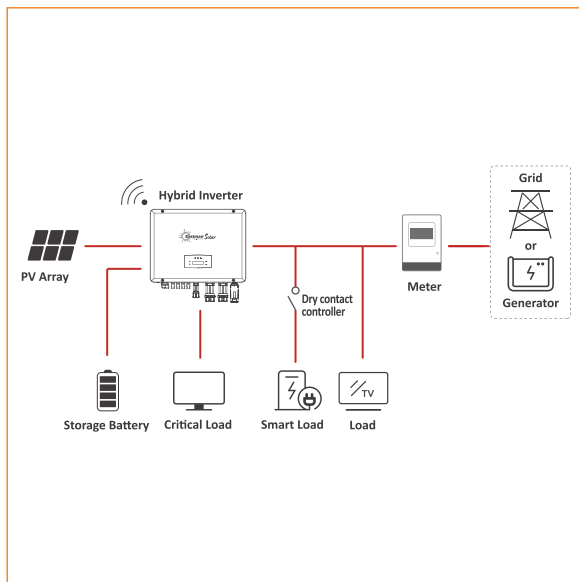

## Product Specifications

MODEL	ES15KW-TH-HY	ES17KW-TH-HY	ES20KW-TH-HY	ES25KW-TH-HY	ES30KW-TH-HY
Nominal Inverter Power (kW)	15kW	17kW	20kW	25kW	30kW
Max. DC Input Power (kW)	22.5	25.5	30	37.5	45
Max. PV Voltage (V)	1000				
MPPT Voltage Range (V)	150 - 850				
Rated DC Input Voltage (V)	620				
Startup Voltage (V)	160				
Max. DC Input Current (A)	20 + 32	32 x 2	32 x 2	40 x 2	40 x 2
Max. Short Current (A)	30 + 48	48 x 2	48 x 2	60 x 2	60 x 2
No. of MPPT Tracker / String	2/3	2/4	2/4	2/4	2/4
Max. Charge/Discharge Power (kW)	15	17	20	25	30
Max. Charge/Discharge Current (A)	50	50	50	60	60
Battery Normal Voltage (V)	500	400	500	500	550
Net Weight (Kgs)	29	29	29	36	36
Dimensions (W x H x D, mm)	558 x 535 x 260				
Warranty	5 Years				



# HYBRID INVERTER SPLIT PHASE 3 ~ 9.6 kW

## Introduction

The Eastman Split Phase series storage inverters are designed to increase energy independence for homeowners. The power range is from 3.0kW to 9.6kW, compatible with high voltage (80-495V) batteries. Energy management is based on time-of-use and demand charge rate structures, significantly reduce the amount of energy purchased from public grid.

## Connection Diagram

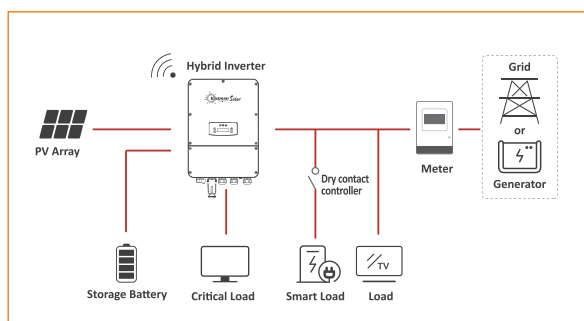

## Product Features

- Configurable Operation Modes.
- Support for Time-of-use Optimization.
- Build in Anti-feed-in Function.
- Compact Size and Easy Installation.
- AFCI & Rapid Shutdown Ready.
- Smart Monitoring & Remote Firmware Upgrade.
- 1.5 Times PV Oversize.
- Up to 3 MPPT Channels. Switch Time<10ms.
- Max.6 Parallel Stacking. Support Generator.
- Support Split-Phase (120/240Vac) Grid.

## Product Specifications

MODEL	ES3KW-DH-HY	ES3.6KW-DH-HY	ES4KW-DH-HY	ES4.6KW-DH-HY	ES5KW-DH-HY	ES5.5KW-DH-HY
Nominal Inverter Power (kW)	4.5	5.4	6.0	6.9	7.5	8.3
Max. PV Voltage (V)	600					
MPPT Range (V)	80-550					
Full MPPT Range (V)	110-550	135-550	150-550	170-550	185-550	200-550
Max. Charge/Discharge Power (kW)	4.5/4.5	5.4/5.4	6.0/6.0	6.9/6.9	7.5/7.5	8.3/8.3
Max. Charge/Discharge Current (A)	50					
Battery Voltage Range (V)	80-495					
Protection Degree	IP65/NEMA4X					
Net Weight (Kgs)	25					
Dimensions (W x H x D, mm)	400*600*229					
Warranty	5 Years					
MODEL	ES6KW-DH-HY	ES7KW-DH-HY	ES7.6KW-DH-HY	ES8KW-DH-HY	ES8.6KW-DH-HY	ES9.6KW-DH-HY
Nominal Inverter Power (kW)	9.0	10.5	11.4	12.0	12.9	15.0
Max. PV Voltage (V)	600					
MPPT Range (V)	80-550					
Full MPPT Range (V)	220-550	170-550	185-550	195-550	210-550	235-550
Max. Charge/Discharge Power (kW)	9.0/9.0	10.5/10.3	11.4/10.3	11.5/10.3	11.5/10.3	11.5/10.3
Max. Charge/Discharge Current (A)	50					
Battery Voltage Range (V)	80-495					
Protection Degree	IP65/NEMA4X					
Net Weight (Kgs)	25					
Dimensions (W x H x D, mm)	400*600*229					
Warranty	5 Years					

# **SOLAR**

# **CHARGE CONTROLLERS**

---







# MPPT SOLAR CHARGE CONTROLLER

## 15A / 20A / 30A / 40A

### Safety

- Over Charging & Discharging Protection
- Overload Protection
- Short Circuit Protection
- Battery Over-Voltage Protection
- Temperature Compensation
- Over Temperature Protection
- Thunder Protection
- Solar Reverse Connected Protection
- EMC Protection
- Battery Reverse Connected Protection
- Power Limited Protection
- Reverse Flow of Current Protection
- Solar Short Circuit Protection
- Overheating Power Reduction Protection
- Solar Over-Voltage Protection

### Applications

Solar RV, Household Solar Energy, Solar Street Lamp, Solar Power Generator, Solar Boat.

### Mechanical Size

15A, 20A, 30A, 40A

Charge and load current	15A	20A	30A	40A
Size (L×W×H)mm	165*123*46	195*123*46	205*157*53	256*157*53
Mounting hole size	φ5mm			
Weight(g)	0.63Kg	0.82Kg	1.2Kg	1.5Kg
Terminal scale	10mm <sup>2</sup> /8AWG		16mm <sup>2</sup> /6AWG	

- Please refer to the indicator diagram on the right

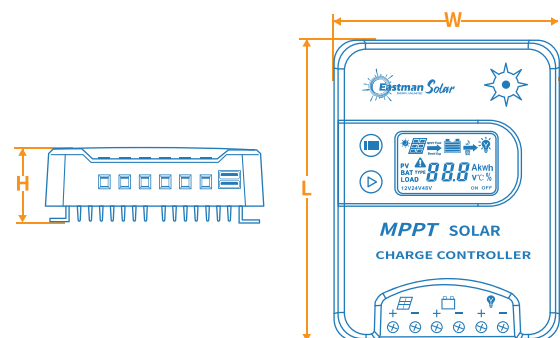

- Dimension reference drawing

### Introduction

Engineered to maximize energy output from your panels, these controllers utilize cutting-edge technology to ensure optimal performance in any environment. Easy to use and highly efficient, they're your gateway to harnessing clean energy effortlessly.

### Product Features

- Advanced MPPT technology, fast and stable track the Maximum Power Point, tracking accuracy 99.5%.
- Adopt Synchronous Rectifier Technology, significantly improve the transfer efficiency of circuit, maximum 98.5%.
- 12/24VDC system voltage automatic recognition.
- Humanized LCD displaying, dynamic display operation data and working state.
- Temperature Compensation Function.
- Accumulation function of charging and Discharging
- Wide MPPT Operating Voltage Range



### Product Specifications

MODELS	ES-15A SUN 75V	ES-20A SUN 75V	ES-30A SUN 75V	ES-40A SUN 75V
System Voltage	12V/24V DC auto			
Working voltage range	8~32V			
Max.PV open circuit voltage	75V (Min.working temp) 70V (25°C)			
MPPT voltage range	(Battery voltage+2V) ~65V			
Discharge circuit voltage drop	≤0.25V			
Self-consumption	<23mA			
Rated charge current	15A	20A	30A	40A
Rated discharge current	15A	20A	30A	40A
Max.PV input power	200W/12A 400W/24V	260W/12A 520W/24V	390W/12A 780W/24V	520W/12A 1040W/24V
Grounding	/			
Battery type	Sealed (Default)/Gel/Flood/Lithium			
LVD ✕*	11.0V ADJ 9V...12V ; ×2/24V ; ×4/48V			
LVR ✕*	12.6V ADJ 11V...13.5V ; ×2/24V ; ×4/48V			
Float Voltage ✕*	13.8V ADJ 13V... 15V ; ×2/24V ; M/48V			
Boost Voltage ✕*	14.4V ADJ 13V...17V ; ×2/24 ; ×4/48V battery voltage less than 12.6v auto boost 2hours			
Battery Over Voltage Protection	16.5V ; ×2/24V ; ×4/48V			
USB Output	5VDC/2A 2PCS			
Temperature Consumption#	For 12Vsystem:-24mV/°C ; ×2/24V ; ×4/48V			
Relative Humidity	≤95%, N.C.			
Working Temperature	-20°C~-+50°C(Product can work continuously at full load)			
LCD temperature range	-20°C~-+70°C			
Waterproof grade	IP32			
Mounting hole size	φ5mm			
Terminals	10mm <sup>2</sup> /8AWG		16mm <sup>2</sup> /6AWG	
Weight	0.63Kg	0.82Kg	1.2Kg	1.5Kg
Overall dimension (mm)	165*123*46mm	195*123*46mm	205*157*53mm	256*157*53mm

#when battery type is setted to Lithium battery, Temperature consumption is 0,unchangeable.

✕ Above the parameters are in 12V system at 25°C, twice in 24V system and quadruple in 48V system.

\*The default value is set based on the lead-acid battery. For other battery type please refer to the manual.

### Connection Diagram

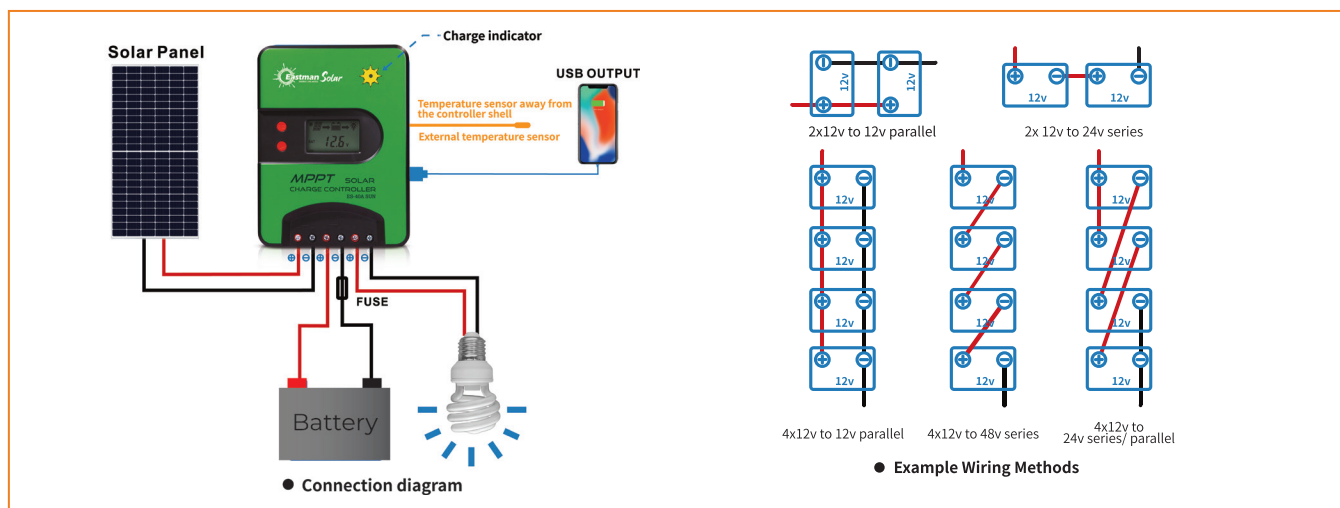



# MPPT SOLAR CHARGE CONTROLLER

30A 100V, 40A 100V | 45A 120V, 60A 120V  
50A 150V, 60A 150V | 30A 150V, 40A 150V

## Safety

- Over Charging & Discharging Protection
- Overload Protection, Short Circuit Protection
- Battery Over-Voltage Protection
- Temperature Compensation
- Over Temperature Protection, Thunder Protection
- Solar Reverse Connected Protection
- EMC Protection
- Battery Reverse Connected Protection
- Power Limited Protection
- Reverse Flow of Current Protection
- Solar Short Circuit Protection
- Overheating Power Reduction Protection
- Solar Over-Voltage Protection

## Applications

Solar RV, Household Solar Energy, Solar Street Lamp, Solar Power Generator, Solar Boat.

## Mechanical Size

### 30A 100V, 40A 100V

Charge and load current	30A	40A
Size (L*W*H)mm	195*183*54	232.5*200.1*54
Mounting hole size	φ5mm	
Weight(g)	1.2Kgs	1.7Kgs
Terminal scale	16mm <sup>2</sup> /6AWG	25mm <sup>2</sup> /4AWG

● Please refer to the indicator diagram on the right

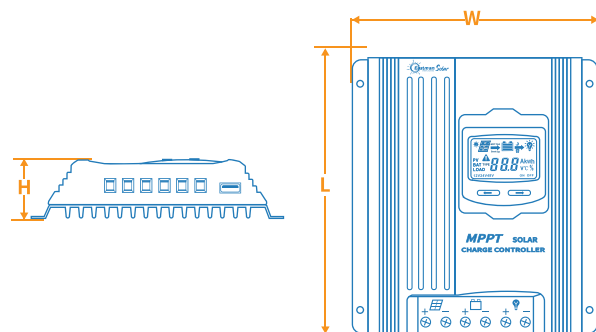

● Dimension reference drawing

## Introduction

Experience the forefront of solar energy optimization with our MPPT solar charge controllers, featuring a user-friendly LCD display, effortlessly monitor and manage your system with intuitive ease.

## Product Features

- Advanced MPPT technology, fast and stable track the Maximum Power Point, tracking accuracy 99.5%.
- Adopt Synchronous Rectifier Technology, significantly improve the transfer efficiency of circuit, maximum 98.5%.
- 12/24VDC or 12V/24V/48V system voltage automatic recognition.
- Humanized LCD displaying, dynamic display operation data and working state.
- Temperature Compensation Function.
- Accumulation function of charging and Discharging.
- Wide MPPT Operating Voltage Range.



# MPPT SOLAR CHARGE CONTROLLER



## Mechanical Size

### 50A 150V, 60A 150V

Charge and load current	50A	60A
Size (L×W×H)mm	277*243*103mm	
Mounting hole size	φ5mm	
Weight(g)	3.9Kgs	4.5Kgs
Terminal scale	25mm <sup>2</sup> /4AWG	25mm <sup>2</sup> /4AWG

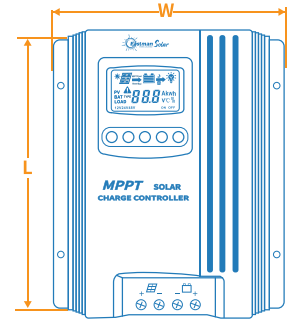
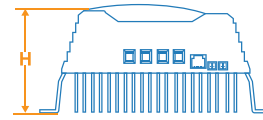

● Please refer to the indicator diagram on the right

● Dimension reference drawing

### 45A 120V, 60A 120V, 30A 150V, 40A 150V

Charge and load current	50A	60A
Size (L×W×H)mm	277*243*103mm	
Mounting hole size	φ5mm	
Weight(g)	3.9Kgs	4.5Kgs
Terminal scale	25mm <sup>2</sup> /4AWG	25mm <sup>2</sup> /4AWG

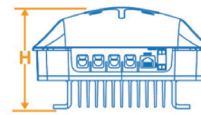

● Please refer to the indicator diagram on the right

● Dimension reference drawing

## Connection Diagram

ES-30A SCC 100V  
ES-40A SCC 100V

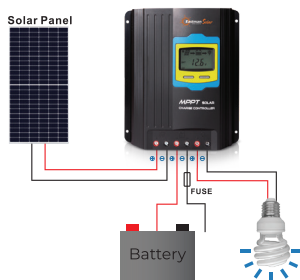

● Connection diagram

ES-50A SCC 150V  
ES-60A SCC 150V

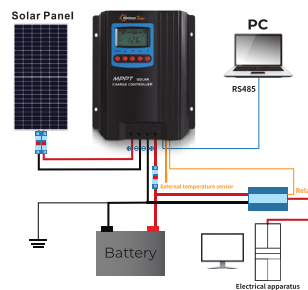

● Connection diagram

ES-45A SCC-120V, ES-60A SCC-120V  
ES-30A SCC-150V, ES-40A SCC-150V

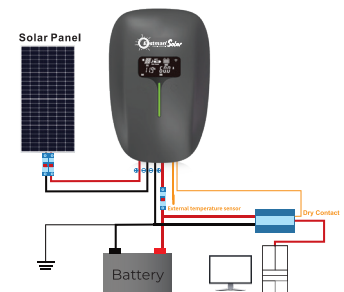

● Connection diagram

# MPPT SOLAR CHARGE CONTROLLER



## Product Specifications

MODELS	ES-30A SCC 100V	ES-40A SCC 100V	ES-50A SCC 150V	ES-60A SCC 150V
System Voltage	12V/24V DC auto		12V/24V/48V DC auto	
Working voltage range	8~32V		8~68V	
Max.PV open circuit voltage	100V (Min.working temp) 95V (25°C)		150V (Min.working temp) 140V (25°C)	
MPPT voltage range	(Battery voltage+2V) ~75V		(Battery voltage+2V) ~125V	
Discharge circuit voltage drop	≤0.25V		-	
Self-consumption	<23mA		<2W	
Rated charge current	30A	40A	50A	60A
Rated discharge current	30A	40A	/	/
Max.PV input power	390W/12V 780W/24V	520W/12V 1040W/24V	650W/12V 1300W/24V 2600W/48V	800W/12V 1600W/24V 3200W/48V
Grounding	Common negative			
Battery type	Sealed (Default)/Gel/Flood/Lithium			
LVD✕*	11.0V ADJ 9V...12V ; ✕2/24V ; ✕4/48V			
LVR✕*	12.6V ADJ 11V...13.5V ; ✕2/24V ; ✕4/48V			
Float Voltage ✕*	13.8V ADJ 13V... 15V ; ✕2/24V ; M/48V			
Boost Voltage ✕*	14.4V ADJ 13V...17V ; ✕2/24 ; ✕4/48V battery voltage less than 12.6v auto boost 2hours			
Battery Over Voltage Protection	16.5V ; ✕2/24V ; ✕4/48V			
USB Output	5VDC/1A 1PCS			
Temperature Consumption#	For 12Vsystem:-24mV/°C ; ✕2/24V ; ✕4/48V			
RS485 interface	Optional		Yes	
Relative humidity	≤95%, N.C.			
Working Temperature	-20°C~+50°C(Product can work continuously at full load)			
LCD temperature range	-20°C~+70°C			
Waterproof Grade	IP32			
Mounting hole size	φ5mm			
Terminals	16mm <sup>2</sup> /6AWG	25mm <sup>2</sup> /4AWG	25mm <sup>2</sup> /4AWG	
Weight	1.2Kgs	1.7Kgs	3.9Kgs	4.5Kgs
Overall Dimension (mm)	195*183*54mm	232.5*200.1*54mm	277*243*103mm	

#when battery type is set to Lithium battery, Temperature consumption is 0,unchangeable.

✕ Above the parameters are in 12V system at 25°C, twice in 24V system and quadruple in 48V system.

\*The default value is set based on the lead-acid battery. For other battery type please refer to the manual.

MODELS	ES-45A SCC-120V	ES-60A SCC-120V	ES-30A SCC-150V	ES-40A SCC-150V
System Voltage	12/24VDC Auto ⊕		12/24/48VDC Auto ⊕	
Rated charge current	45A	60A	30A	40A
Battery voltage range	8~32V		8~68V	
Max.PV open circuit voltage	⊕ 110V	⊕ 120V	⊕ 138V	⊕ 150V
MPPT voltage range	(Battery voltage +2V)~85V		(Battery voltage +2V)~108V	
Rated charge power	580W/12V 1170W/24V	800W/12V 1600W/24V	390W/12V 780W/24V 1560W/48V	520W/12V 1040W/24V 2080W/48V
Self-consumption	≤70mA(12V)40mA(24V)24mA(48V)			
LVD	11.0V ADJ 9V...12V ; ✕2/24V ; ✕4/48V			
LVR	12.6V ADJ 11V...13.5V ; ✕2/24V ; ✕4/48V			
Float Voltage	13.8V ADJ 13V... 15V ; ✕2/24V ; 4/48V			
Boost Voltage	14.4V ; ✕2/24 ; ✕4/48V battery voltage less than Boost Restart Voltage Start Boost charging for 2 hours			
MPPT tracking efficiency	≥99.5%			
Max. Conversion efficiency	98%			
Grounding	Common negative			
Battery Type	Sealed(Default)/Gel/Flooded/LiFePO4/ Li(NiCoMn)O2/User			
Temperature compensate ⊕	-4mv/°C/2V			
Communication method	RS485(5VDC/200mA)			

⊕ When a lithium battery is used, the system voltage can't be identified automatically. ⊕ At minimum operating environment temperature.

⊕ At 25°C environment temperature. ⊕ When a lithium battery is used, the temperature compensate coefficient will be 0.



# MPPT SOLAR CHARGE CONTROLLER 80A / 100A

## Safety

- Over Charging & Discharging Protection
- Overload Protection, Short Circuit Protection
- Battery Over-Voltage Protection
- Temperature Compensation
- Over Temperature Protection, Thunder Protection
- Solar Reverse Connected Protection
- EMC Protection
- Battery Reverse Connected Protection
- Power Limited Protection
- Reverse Flow of Current Protection
- Solar Short Circuit Protection
- Overheating Power Reduction Protection
- Solar Over-Voltage Protection

## Applications

Solar RV, Household Solar Energy, Solar Street Lamp, Solar Power Generator, Solar Boat.

## Mechanical Size

**80A 200V, 100A 200V**

Charge and load current	80A	100A
Size (L×W×H)mm	375*244*135.5	
Mounting hole size	φ7mm	
Weight	6.8Kgs	8.2Kgs

● Please refer to the indicator diagram on the right

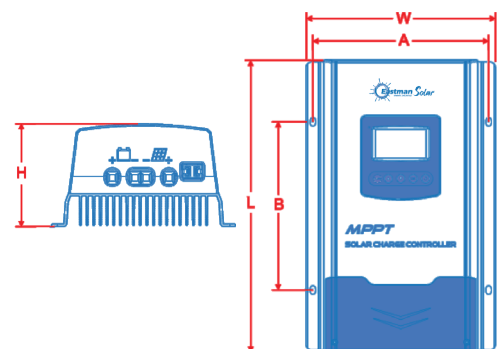

● Dimension reference drawing

## Introduction

Eastman SCC is the ultimate solution for various solar applications like household energy systems, solar street lamps, and power generators. With user-friendly controls, it's versatile and essential for sustainable, reliable solar energy usage.

## Product Features

- Advanced MPPT technology, fast and stable track the Maximum Power Point, tracking accuracy 99.5%.
- Auto-control of utility and generator dry contact design to compose a hybrid power system easily.
- Real-time working record function.
- 12/24V/48VDC System voltage automatic recognition.
- Load dry contact to control the external load switch.
- Power reduction automatically over temperature range.
- TVS lightning protection.
- Humanized LCD Displaying
- Accumulation function of charging and Discharging
- Wide MPPT Operating Voltage Range



# MPPT SOLAR CHARGE CONTROLLER



## Product Specifications

MODELS	ES-80A SCC 200V			ES-100A SCC 200V		
System nominal voltage	12/24/48VDC Auto ①					
Rated charge current	80A			100A		
Battery voltage range	8~68V					
Max. PV open circuit voltage	②180V ③200V					
MPPT voltage range	(Battery voltage +2V)~ 144V					
Max. PV input power	1000W/12V	2100W/24V	4200W/48V	1300W/12V	2600W/24V	5200W/48V
Self-consumption	≤70mA(12V)/40mA(24V)/24mA(48V)					
LVD	11.0V ADJ 9V...12V; ×2/24V; ×4/48V					
LVR	12.6V ADJ 11V...13.5V; ×2/24V; ×4/48V					
Float voltage	13.8V ADJ 13V...15V; ×2/24V;;×4/48V					
Boost voltage	14.4V ; ×2/24; ×4/48V Battery Voltage less than 12.6V Start Boost changing for 2hours(Li-battery not)					
MPPT tracking efficiency	≥99.5%					
Max. Conversion efficiency	98%					
Grounding	Common negative					
Battery Type	Sealed(Default)/Gel/Flooded/LiFePO4/ Li(NiCoMn)02/ User					
Temperature compensate Coefficient④	-4mv/°C/2V					
Dry contact	Rated value: 3A/30VDC; Max. value: 0.5A/60VDC					
Communication method	RS485					
LCD backlight time	Default: 15S					
Protection Level	IP32					

①When a lithium battery is used, the system voltage can't be identified automatically. ②At minimum operating environment temperature  
 ③At 25°C environment temperature ④When a lithium battery is used, the temperature compensate coefficient will be 0.

## Connection Diagram

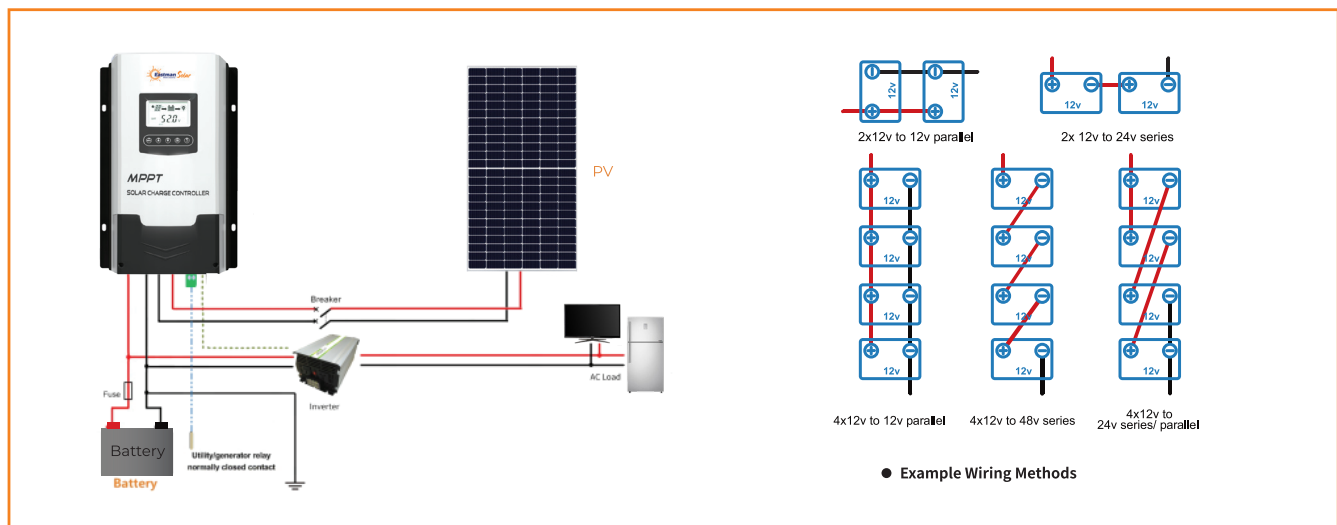



**SOLAR CHARGE CONTROLLER**

# MPPT CHARGE CONTROLLER-ECO

40A | 60A | 80A | 100A

## Introduction

Eastman MPPT Solar Charge Controller is a high-performance device designed to efficiently convert solar energy into usable power for charging batteries. With its Maximum Power Point Tracking (MPPT) technology, this controller can maximize the energy harvested from solar panels, ensuring optimal charging efficiency. Suitable for both residential and commercial solar systems, this MPPT Solar Charge Controller is a reliable and essential component for maximizing the performance of your solar power setup

## Solar Energy System Wiring Diagram

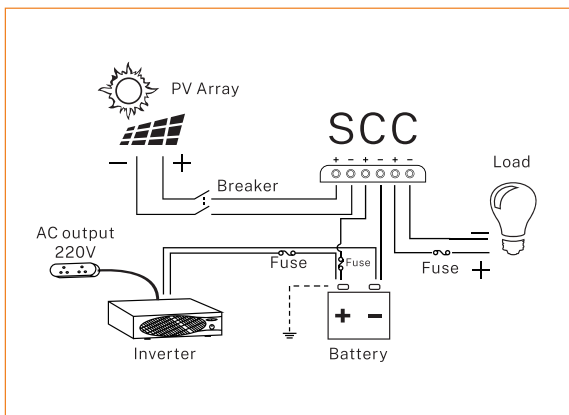

## Product Features

- Advanced MPPT technology, fast and stable track the Maximum Power Point, tracking accuracy 99.00%.
- Adopt Synchronous Rectifier Technology, significantly improve the transfer efficiency of circuit, maximum 97.00%.
- 12/24VDC system voltage automatic recognition.
- Humanized LCD displaying, dynamic display operation data and working state.
- Temperature Compensation Function.

## Certifications



## Perform the Following Steps to Connect Cables and Install Them

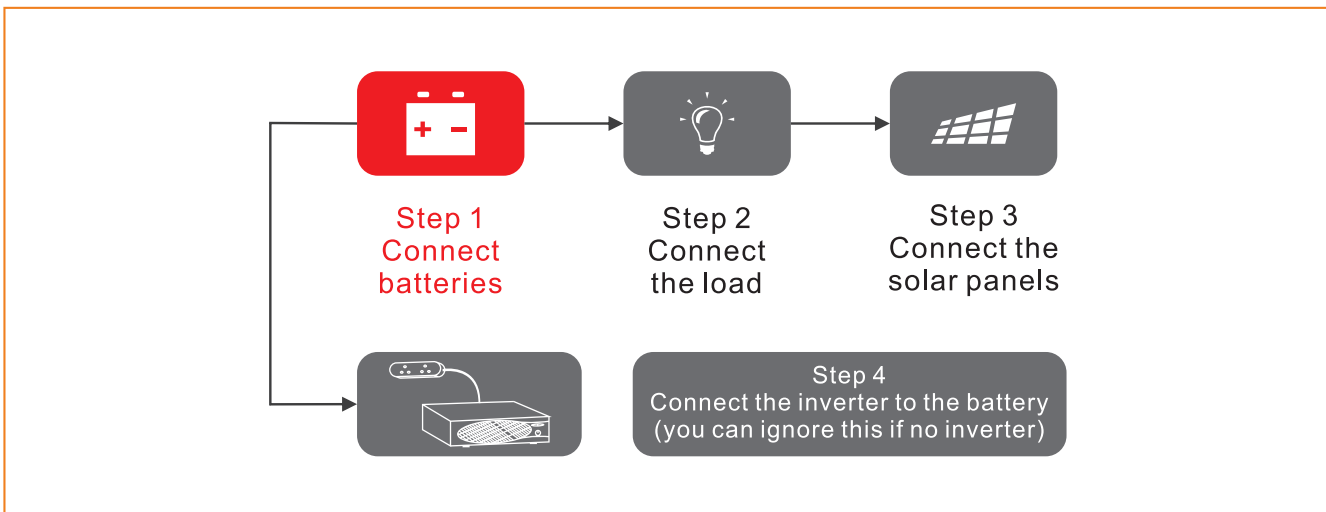

# MPPT CHARGE CONTROLLER-ECO



## Product Specifications

MODELS	ES40A-ECO 100V-SCC	ES60A-ECO 150V-SCC	ES80A-ECO 200V-SCC	ES100A-ECO 200V-SCC
Battery Type	GEL, SLD,FLD and USR(default), Lithium batteries customization 3.7V*3s,3.7V*4s,3.2V*4s,3.2V*5s	GEL, SLD,FLD and USR(default), Lithium batteries customization 3.7V*3s,3.7V*4s,3.2V*4s,3.2V*5s	GEL, SLD,FLD and USR(default), Lithium batteries customization 3.7V*3s,3.7V*4s,3.2V*4s,3.2V*5s	GEL, SLD,FLD and USR(default), Lithium batteries customization 3.7V*3s,3.7V*4s,3.2V*4s,3.2V*5s
Battery Input Voltage Range	9~15VDC/18~30VDC	9~15VDC/18~30VDC/36~60VDC	9~15VDC/18~30VDC/36~60VDC	9~15VDC/18~30VDC/36~60VDC
Rated Charge Current	40A	60A	80A	100A
Rated Output Current	40A	60A	80A	100A
Display	LCD	LCD	LCD	LCD
Max PV Voc	<100V	<150V	<200V	<200V
Nominal System Voltage	12V/24V (auto)	12/24/48V (auto)	12/24/48V (auto)	12/24/48V (auto)
Max efficiency	97.00%	97.00%	97.00%	97.00%
MPPT Efficiency	99.00%	99.00%	99.00%	99.00%
Cooling	Natural (without Fan)	Natural (without Fan)	Natural (without Fan)	Natural (without Fan)
Self-consumption	≤60mA(12v) ≤50mA(24v)	≤35mA (48V)	≤35mA (48V)	≤35mA (48V)
Temperature compensation	-3mv/°C/2v(Default)	-3mv/°C/2v(Default)	-4mv/°C/2v(Default)	-4mv/°C/2v(Default)
Relative Humidity	≤90%, N.C	≤90%, N.C	≤90%, N.C	≤90%, N.C
Enclosure	IP20	IP20	IP20	IP20
Communication Interface	RS485(RJ45)	RS485(RJ45)	RS485(RJ45)	RS485(RJ45)
Grounding	positive °C	positive °C	positive °C	positive °C
Operating Temperature	-20~55°C(environment 50°C max current 2hours no derating)	-20~55°C(environment 50°C max current 2hours no derating)	-20~55°C(environment 50°C max current 2hours no derating)	-20~55°C(environment 50°C max current 2hours no derating)
Dimension	215*145*75	188*280*94	265*179*100	340*200*115
Netweight	1.318kg	2.8kg	3kg	4kg
Warranty	3 Years	3 Years	3 Years	3 Years
Optional accessories	Wifi/Bluetooth	Wifi/Bluetooth	Wifi/Bluetooth	Wifi/Bluetooth
VOLTAGE				
MPPT Voltage Range	15~80VDC/30~80VDC	15~130VDC/30~130VDC/60~130VDC	15~170VDC/30~170VDC/60~170VDC	15~170VDC/30~170VDC/60~170VDC
Equalization Voltage	14.6V/29.2V	14.6V/29.2V/58.4V	14.6V/29.2V/58.4V	14.6V/29.2V/58.4V
Boost Voltage	Gel:14.2v/28.4v, sealed:14.4v/28.8v, flooded:14.6v/29.2v,	Gel:14.2v/28.4v/56.8v, sealed:14.4v/28.8v/57.6v, flooded:14.6v/29.2v/58.4v,	Gel:14.2v/28.4v/56.8v, sealed:14.4v/28.8v/57.6v, flooded:14.6v/29.2v/58.4v,	Gel:14.2v/28.4v/56.8v, sealed:14.4v/28.8v/57.6v, flooded:14.6v/29.2v/58.4v
Float Voltage	Gel/sealed/flooded:13.8v,/27.6v	Gel/sealed/flooded:13.8v,/27.6v/55.2v	Gel/sealed/flooded:13.8v,/27.6v/55.2v	Gel/sealed/flooded:13.8v,/27.6v/55.2v
Reconnect voltage	Gel/sealed/flooded:12.6v,/25.2v	Gel/sealed/flooded:12.6v,/25.2v,/50.4v	Gel/sealed/flooded:12.6v,/25.2v,/50.4v	Gel/sealed/flooded:12.6v,/25.2v,/50.4v
Disconnect voltage	Gel/sealed/flooded:10.8v,/21.6v	Gel/sealed/flooded:10.8v,/21.6v,/43.2v	Gel/sealed/flooded:10.8v,/21.6v,/43.2v	Gel/sealed/flooded:10.8v,/21.6v,/43.2v

# **SOLAR PUMP INVERTERS**

---





# MPPT PUMP INVERTER

0.4kW~200kW



## Product Features

- Support for driving single-phase 220V and three-phase 220V/380V pumps, the power from 0.4kW to 200kW.
- The inverters automatically start or sleep only after being connected to solar panel without any parameter setting.
- Including PV over voltage protection, PV polarity reverse warning, auto derating against over-temperature etc, which can extend product's life.
- Implement auto switch between solar input and grid input, achieved 24-hour unattended work.
- Ensure the solar power tracking efficiency reaches 99%
- Support the GPRS module, which can remote monitor the inverter by using the APP
- Support cabinet product for IP54 protection level

## Introduction

Eastman solar pump inverter is a crucial component of a solar-powered water pumping system. It converts the DC power generated by solar panels into AC power to drive the water pump, enabling efficient and reliable water pumping without the need for grid electricity. These inverters often come equipped with features such as maximum power point tracking (MPPT) to optimize energy production from the solar panels and ensure consistent water supply, making them ideal for agricultural, irrigation, and water supply applications in off-grid or remote areas.

## Product Application

- Domestic Water
- Municipal Water
- Agriculture Irrigation
- Pasture Animal Husbandry
- Desert Oasis Irrigation

## Application Diagram

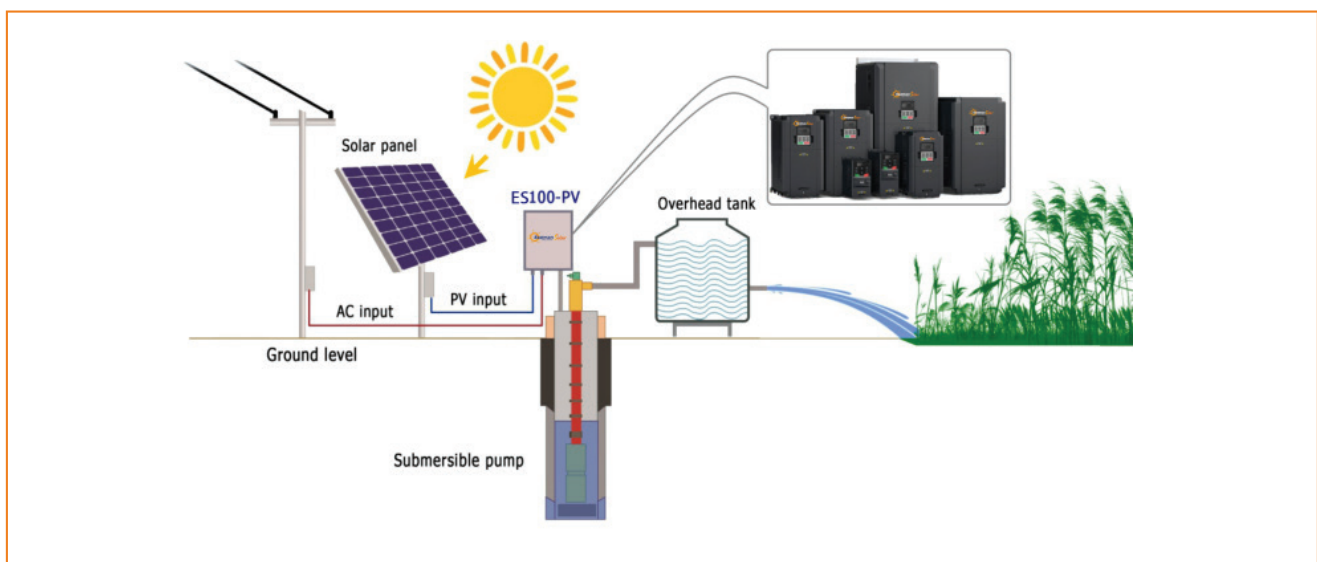

# MPPT SOLAR PUMP INVERTER

**ES100 - 5.5 - 4 5 - PV**  
 ①      ②      ③      ④      ⑤

## Type Designation Key

Field Identification	Sign	Detailed Description of the Sign	Remarks
Product abbreviation	①	Product abbreviation	ES100 is short for EASTMANSOLAR100
Rated Power	②	Power range	5.5: 5.5kW
Voltage Degree	③	Voltage Degree	4: AC 3PH 380V (-15%)—440(+10%) 2: AC 1PH Input/Output 220V (-15%)—240(+10%)
Protection Level	④	Protection Level	IP20
Industrial Code	⑤	Industrial Code	PV Stands for solar pump

## Product Rated Specificaion Parameters

Series	Models	Rated Output Power(kW)	Dimensions L*W*H(mm)	Net Weight Gross Weight (KG)
1PH 220V Input 1PH 220V Output	ES100-0.4-2-PV	0.4	215*125*180	0.9/1.1
	ES100-0.7-2-PV	0.75	215*125*180	0.9/1.1
	ES100-1.5-2-PV	1.5	242*130*120	1.2/1.5
	ES100-2.2-2-PV	2.2	242*130*120	1.2/1.5
3PH 380V	ES100-5.5-4-PV	5.5	343*230*270	3/3.6
	ES100-7.5-4-PV	7.5	343*230*270	3/3.6
	ES100-011-4-PV	11	430*280*330	6/7
	ES100-015-4-PV	15	430*280*330	6/7
	ES100-022-4-PV	22	490*315*315	8.5/10
	ES100-030-4-PV	30	490*315*315	8.5/10
	ES100-045-4-PV	45	580*395*360	13.5/14.5
	ES100-055-4-PV	55	410*695*470	30/32
	ES100-075-4-PV	75	410*695*470	30/32
	ES100-090-4-PV	90	445*760*580	47/67
	ES100-110-4-PV	110	445*760*580	47/67
	ES100-132-4-PV	132	445*760*580	47/67
	ES100-160-4-PV	160	631*971*565	85/101
	ES100-185-4-PV	185	631*971*565	85/101
	ES100-200-4-PV	200	631*971*565	85/101

## Product Specificaions

Series	1PH 220V	3PH 380V
AC Input Voltage (V)	220(-15%) -240(+10%) (1PH)	380(-15%) -440(+10%) (3PH)
Max. DC Input Voltage (V)	440	800
Start-up Voltage (V)	200	300
Lowest Working Voltage (V)	150	250
Recommended DC Input Voltage Range (V)	200-400	300-750
Recommended MPP Voltage (V)	330	550
Rated Output Voltage (V)	220 (1PH)	380 (3PH)
Output Frequency Range (Hz)	0-400	
Efficiency	99%	
Insttallation Manner	Wall mounting/Rail mounting/Flange mounting	
Environment Temperature	-10°C-+50°C, If above 40°C, derate 2% for every additional 1°C.	
Altitude	Below 1000m, If above 1000m, derate 1% for every additional 100m.	
Cooling Manner	Fan cooling	
Protection Level	IP20	

# **SOLAR** *PANELS*

---

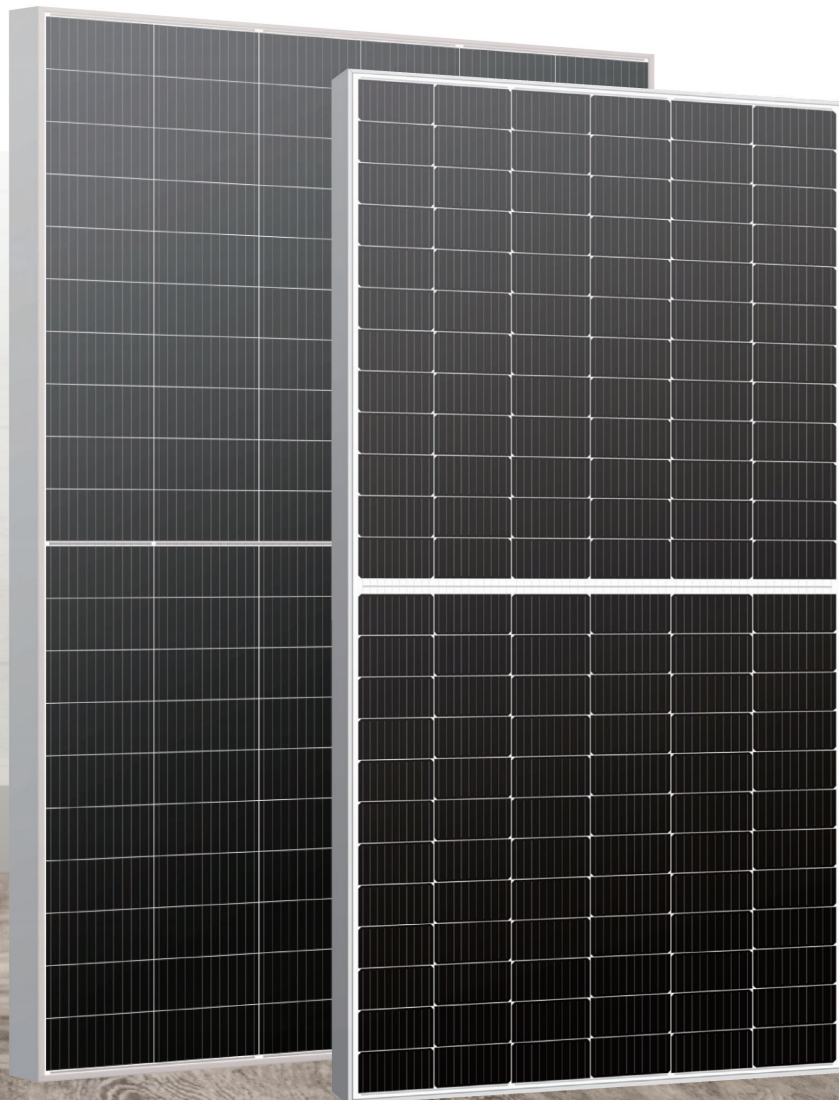



# SOLAR PANEL P-TYPE 450W

Monocrystalline Module  
Half-cell Module

## Introduction

Introducing our P-TYPE Monocrystalline Module, an advanced solar panel that offers higher output power compared to traditional modules. With its advanced technology, this module boasts an impressive efficiency of up to 20.9%, ensuring maximum energy conversion from sunlight.

## Product Features

- Higher output power
- Module efficiency up to 20.9%
- Lower temperature coefficient
- Lower LCOE (Levelized Cost Of Energy)
- High Power output lead to lower BOS cost
- Salt Mist Corrosion Protect
- Ammonia Resistance
- Excellent Potential Induced Degradation Resistance
- Excellent Wind Load 2400Pa & Snow Load 5400Pa Under Certain Installation Method

## System & Product Certificates

- ISO9001:2015 Quality Management system
- ISO14001:2015 Environmental Management System
- ISO45001:2018 Occupational Health and Safety Management System

## Module Structure Drawing

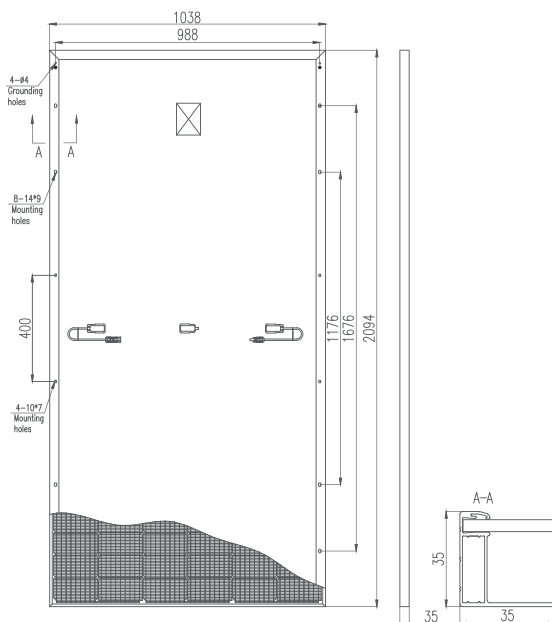

\*400mm mounting holes are only suitable for 6005-T6 aluminum frame

## Performance Warranty



■ Linear Performance Warranty

□ Standard Performance Warranty

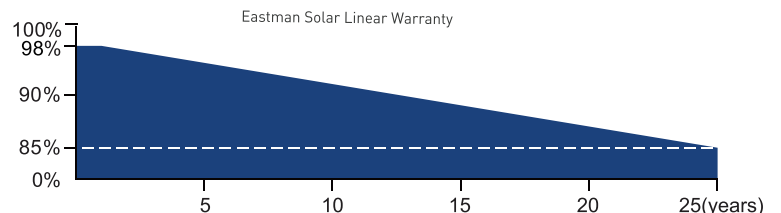



## I-V Curves

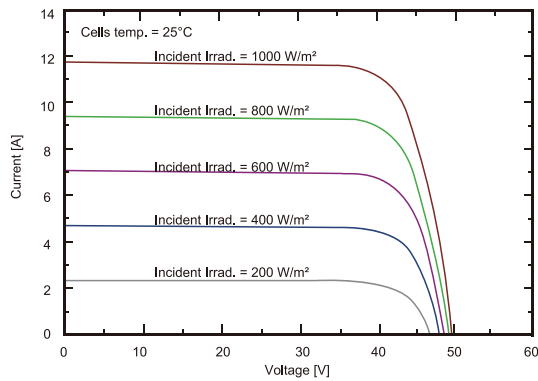

## P-V Curves

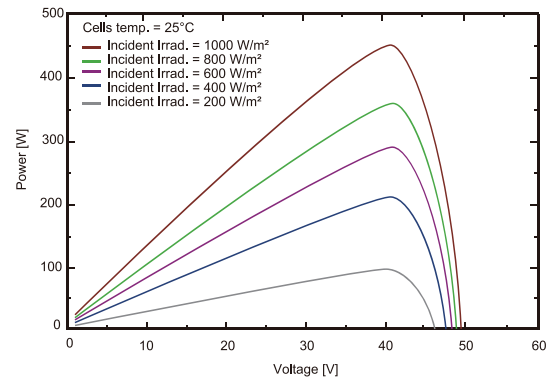

## Product Specifications

Model	ES450MP
<b>Electrical Characteristics(STC*)</b>	
Power Output(Wp)	450
Max Power Tolerance(W)	0-5
Module Efficiency(%)	20.7
Voltage Mpp-Vmpp(V)	41.47
Current Mpp-Impp(A)	10.85
Voltage Open Circuit-Voc(V)	49.51
Short Circuit Current-Isc(A)	11.78
<b>Electrical Characteristics(NMOT*)</b>	
Power Output(Wp)	345.71
Voltage Mpp-Vmpp(V)	37.80
Current Mpp-Impp(A)	9.14
Voltage Open Circuit-Voc(V)	45.71
Short Circuit Current-Isc(A)	10.02
<b>Mechanical Data</b>	
Dimension Of Module	2094*1038*35mm
Weight	24kg
Glass	High transmission glass 3.2mm
Cables	4mm <sup>2</sup> /300mm or Customized Length
Junction Box	IP68,3 Bypass-Diode
Connector	MC4 compatible
<b>Packaging Configuration</b>	
Container	40'HQ
Pieces Per Pallet	31
Pallets Per Container	22
Pieces Per Container	682
<b>Working Conditions</b>	
Max System Voltage(VDC)	1500V
Max Series Fuse Rating	20A
Maximum Load Capacity	Snow 5400Pa/Wind 2400Pa
Operating Temperature	-40°C~+85°C
Safety Class	II
<b>Temperature Ratings</b>	
Temperature Coefficients of Isc(%/°C)	0.046
Temperature Coefficients of Voc(%/°C)	-0.266
Temperature Coefficients of Pmpp(%/°C)	-0.354
NMOT	45±2°C

\*STC:Irradiance 1000 W/m<sup>2</sup>, Environment Temperature 25°C,Air Mass AM1.5

\*NMOT:Irradiance 800 W/m<sup>2</sup>, Environment Temperature 20°C, Air Mass AM1.5



# SOLAR PANEL P-TYPE 550W

Monocrystalline Module  
Half-cell Module

## Introduction

Introducing our P-TYPE Monocrystalline Module, an advanced solar panel that offers higher output power compared to traditional modules. With its advanced technology, this module boasts an impressive efficiency of up to 21.3%, ensuring maximum energy conversion from sunlight.

## Product Features

- Higher output power
- Module efficiency up to 21.3%
- Lower temperature coefficient
- Lower LCOE (Levelized Cost Of Energy)
- High Power output lead to lower BOS cost
- Salt Mist Corrosion Protect
- Ammonia Resistance
- Excellent Potential Induced Degradation Resistance
- Excellent Wind Load 2400Pa & Snow Load 5400Pa Under Certain Installation Method

## System & Product Certificates

- ISO9001:2015 Quality Management system
- ISO14001:2015 Environmental Management System
- ISO45001:2018 Occupational Health and Safety Management System

## Module Structure Drawing

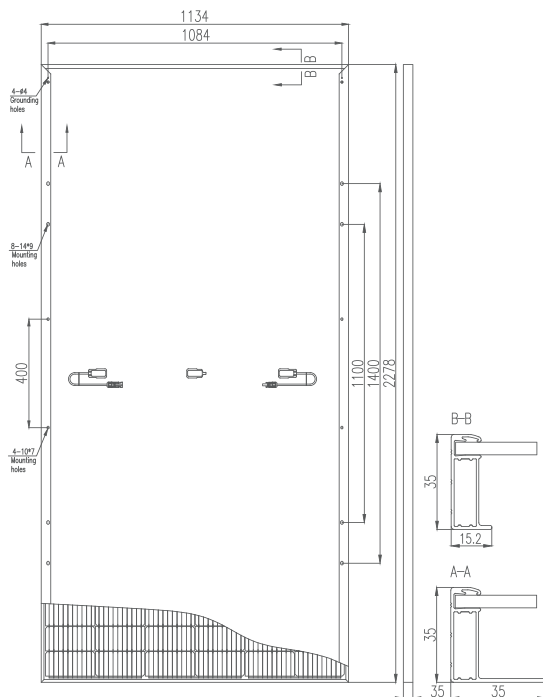

Note: 400mm hole distance is only applicable when specified by the customer

## Performance Warranty



■ Linear Performance Warranty

■ Standard Performance Warranty

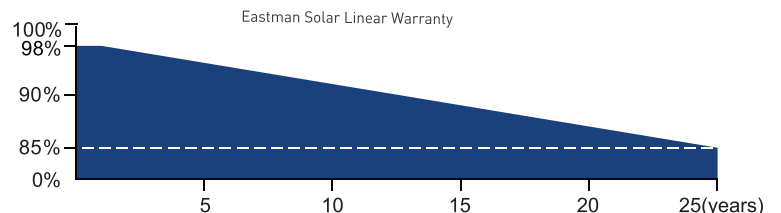

# ES550MP P-TYPE

## Curves

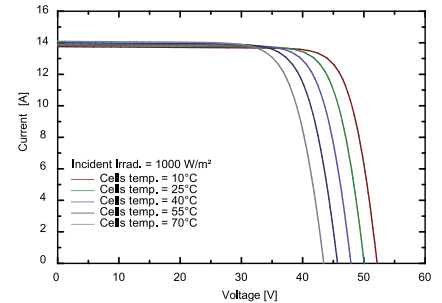
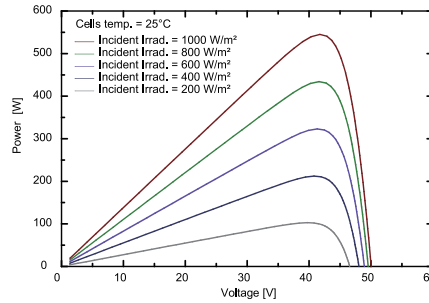
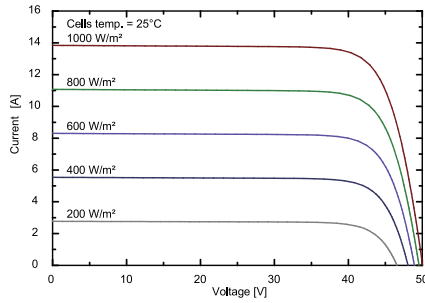

## Product Specifications

Model	ES550MP
<b>Electrical Characteristics(STC*)</b>	
Power Output(Wp)	550
Max Power Tolerance(W)	0-5
Module Efficiency(%)	21.3
Voltage Mpp-Vmpp(V)	42.11
Current Mpp-Impp(A)	13.06
Voltage Open Circuit-Voc(V)	50.28
Short Circuit Current-Isc(A)	13.90
<b>Electrical Characteristics(NMOT*)</b>	
Power Output(Wp)	422.53
Voltage Mpp-Vmpp(V)	38.39
Current Mpp-Impp(A)	11.01
Voltage Open Circuit-Voc(V)	46.42
Short Circuit Current-Isc(A)	11.82
<b>Mechanical Data</b>	
Dimension Of Module	2278*1134*35mm
Weight	27kg
Glass	High transmission glass 3.2mm
Cables	4mm <sup>2</sup> /300mm or Customized Length
Junction Box	IP68,3 bypass diodes
Connector	MC4 compatible
<b>Packaging Configuration</b>	
Container	40'HQ
Pieces Per Pallet	31
Pallets Per Container	20
Pieces Per Container	620
<b>Working Conditions</b>	
Max System Voltage(VDC)	1500V
Max Series Fuse Rating	25A
Maximum Load Capacity	Snow 5400Pa/Wind 2400Pa
Operating Temperature	-40°C~+85°C
Safety Class	II
<b>Temperature Ratings</b>	
Temperature Coefficients of Isc(%/°C)	0.046
Temperature Coefficients of Voc(%/°C)	-0.266
Temperature Coefficients of Pmpp(%/°C)	-0.354
NMOT	45±2°C

\*STC:Irradiance 1000 W/m<sup>2</sup>, Environment Temperature 25°C,Air Mass AM1.5

\*NMOT:Irradiance 800 W/m<sup>2</sup>, Environment Temperature 20°C, Air Mass AM1.5



# SOLAR PANEL P-TYPE 585W

Monocrystalline Module  
Half-cell Module

## Introduction

Introducing our P-TYPE Monocrystalline Module, an advanced solar panel that offers higher output power compared to traditional modules. With its advanced technology, this module boasts an impressive efficiency of up to 21.4%, ensuring maximum energy conversion from sunlight.

## Product Features

- Higher output power
- Module efficiency up to 21.4%
- Lower temperature coefficient
- Lower LCOE (Levelized Cost Of Energy)
- High Power output lead to lower BOS cost
- Salt Mist Corrosion Protect
- Ammonia Resistance
- Excellent Potential Induced Degradation Resistance
- Excellent Wind Load 2400Pa & Snow Load 5400Pa Under Certain Installation Method

## System & Product Certificates

- ISO9001:2015 Quality Management system
- ISO14001:2015 Environmental Management System
- ISO45001:2018 Occupational Health and Safety Management System

## Module Structure Drawing

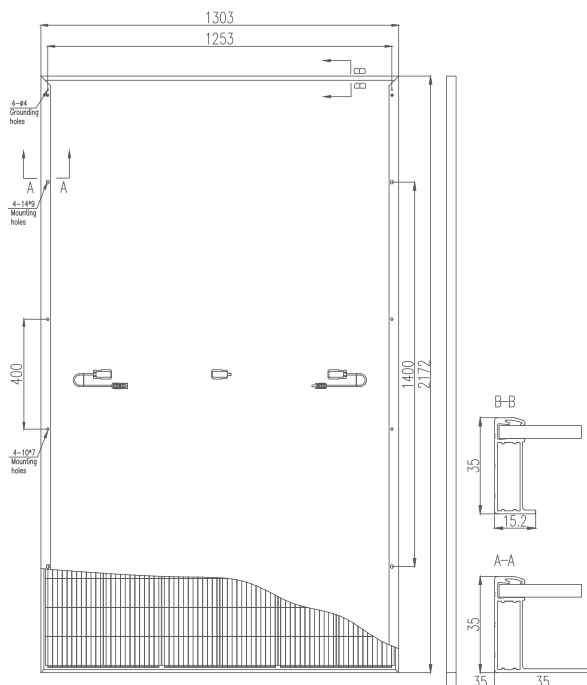

Note: 400mm hole distance is only applicable when specified by the customer

## Performance Warranty



■ Linear Performance Warranty

■ Standard Performance Warranty

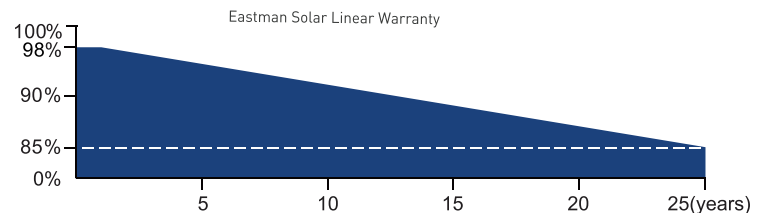



# ES585MP P-TYPE

## Curves

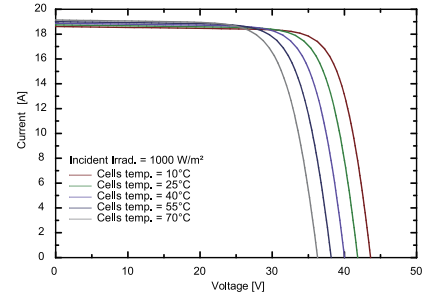
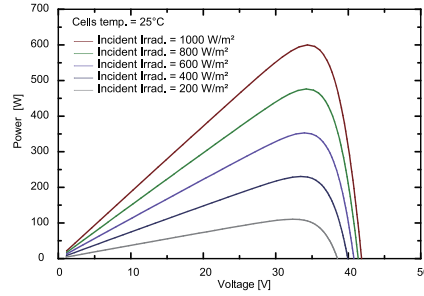
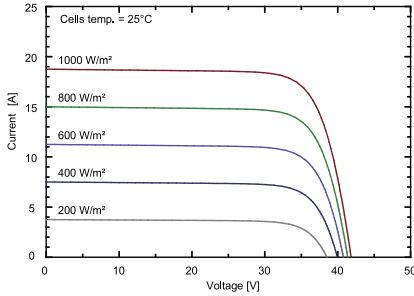

## Product Specifications

Model	ES585MP
<b>Electrical Characteristics(STC*)</b>	
Power Output(Wp)	585
Max Power Tolerance(W)	0-5
Module Efficiency(%)	20.7
Voltage Mpp-Vmpp(V)	33.95
Current Mpp-Impp(A)	17.23
Voltage Open Circuit-Voc(V)	41.24
Short Circuit Current-Isc(A)	18.60
<b>Electrical Characteristics(NMOT*)</b>	
Power Output(Wp)	449.42
Voltage Mpp-Vmpp(V)	30.95
Current Mpp-Impp(A)	14.52
Voltage Open Circuit-Voc(V)	38.08
Short Circuit Current-Isc(A)	15.81
<b>Mechanical Data</b>	
Dimension Of Module	2172*1303*35mm
Weight	31kg
Glass	High transmission glass 3.2mm
Cables	4mm <sup>2</sup> /300mm or Customized Length
Junction Box	IP68,3 bypass diodes
Connector	MC4 compatible
<b>Packaging Configuration</b>	
Container	40'HQ
Pieces Per Pallet	31
Pallet Per Container	18
Pieces Per Container	558
<b>Working Conditions</b>	
Max System Voltage(VDC)	1500V
Max Series Fuse Rating	30A
Maximum Load Capacity	Snow 5400Pa/Wind 2400Pa
Operating Temperature	-40°C~+85°C
Safety Class	II
<b>Temperature Ratings</b>	
Temperature Coefficients of Isc(%/°C)	0.046
Temperature Coefficients of Voc(%/°C)	-0.266
Temperature Coefficients of Pmpp(%/°C)	-0.354
NMOT	45±2°C

\*STC:Irradiance 1000 W/m<sup>2</sup>, Environment Temperature 25°C,Air Mass AM1.5

\*NMOT:Irradiance 800 W/m<sup>2</sup>, Environment Temperature 20°C, Air Mass AM1.5



# SOLAR PANEL N-TYPE 565W~585W TP

Half-cell Mono Module

## Introduction

Introducing our N-TYPE cutting-edge solar panel: engineered for maximum power output and reliability, even in low-light conditions like cloudy days. Featuring zero Light Induced Degradation (LID) and superior temperature coefficient for consistent performance. Certified to withstand harsh environments, it's your reliable solution for sustainable energy.

## Product Features

- **High Power Output:** Better light trapping and current collection to improve module power output and reliability
- **Outstanding Low Light Performance:** Higher power output even under low-light environments like on cloudy or foggy days.
- **Zero LID (Light Induced Degradation):** N-type solar cell has no LID naturally which can increase power generation
- **Better Temperature Coefficient:** Higher power generation under working conditions, thanks to passivating contact cell technology
- **PID Resistance:** Excellent Anti-PID performance guarantee via optimized mass-production process and materials control
- **Enhanced Mechanical Load:** Certified to withstand: wind load (2400 Pascal) and snow load (5400 Pascal)
- **Withstanding Harsh Environment:** Reliable quality leads to a better sustainability even in harsh environment like desert, farm and coastline.

## System & Product Certificates

- IEC61215, IEC61730
- ISO9001:2015: Quality Management System
- ISO14001:2015: Environment Management System
- ISO45001:2018: Occupational health and safety management systems

## Module Structure Drawing

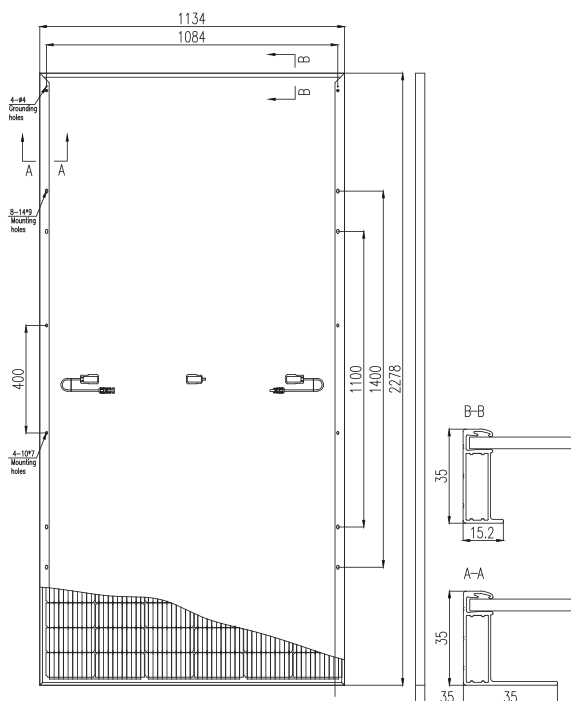

Note: 400mm hole distance is only applicable when specified by the customer

## Performance Warranty

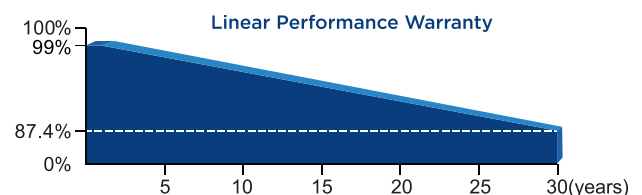

12 Years Product Warranty on Materials and Workmanship

30 Years Linear Performance Warranty

0.40% Subsequent Annual Degradation

# ES565TP ~ ES585TP N-TYPE

## Characteristic Curves(570W)

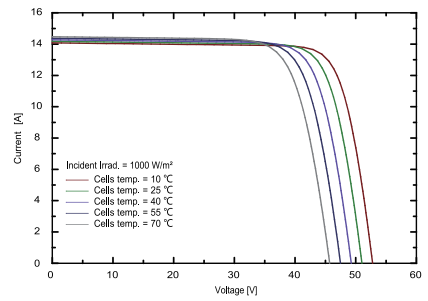
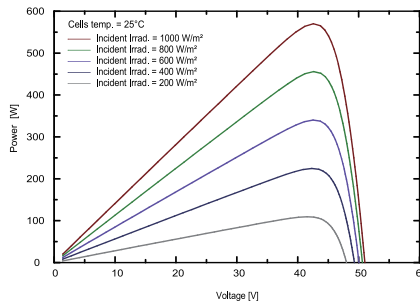
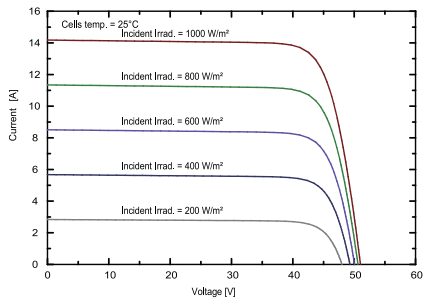

## Product Specifications

Model	ES565TP	ES570TP	ES575TP	ES580TP	ES585TP
<b>Electrical Properties(STC*)</b>					
Power Output(Wp)	565	570	575	580	585
Max Power Tolerance(W)	0-5	0-5	0-5	0-5	0-5
Module Efficiency(%)	21.87	22.07	22.26	22.45	22.65
Voltage Mpp-Vmpp(V)	42.35	42.51	42.69	42.87	43.02
Current Mpp-Impp(A)	13.34	13.41	13.47	13.53	13.60
Voltage Open Circuit-Voc(V)	50.83	51.03	51.23	51.43	51.63
Short Circuit Current-Isc(A)	14.12	14.18	14.24	14.30	14.36
<b>Electrical Properties(NMOT*)</b>					
Power Output(Wp)	427	431	435	439	443
Voltage Mpp-Vmpp(V)	39.79	39.98	40.13	40.28	40.44
Current Mpp-Impp(A)	10.73	10.78	10.84	10.90	10.96
Voltage Open Circuit-Voc(V)	48.45	48.64	48.83	49.02	49.21
Short Circuit Current-Isc(A)	11.40	11.45	11.49	11.54	11.59
<b>Mechanical Properties</b>					
Cell Size	182mm*91mm				
Number of Cells	144 [ 2 x ( 12x 6 ) ]				
Module Dimension	2278*1134*30&2278*1134*35mm				
Weight	27 kg				
Front Glass	High transmission glass 3.2mm				
Frame	Anodized Aluminium Alloy				
Junction Box	IP68 (3 diodes)				
Cable Lenth	TUV 1x4.0mm², (+):300mm/(-):200mm or Customized length				
<b>Operating Properties</b>					
Operating Temperature	-40°C~+85°C				
Maximum System Voltage	1500V DC (IEC)				
Maximum Series Fuse Rating	25A				
Power Tolerance	0~+5W				
<b>Temperature Coefficient</b>					
Temperature Coefficient of Pmax	-0.31%/°C				
Temperature Coefficients of Voc	-0.26%/°C				
Temperature Coefficients of Isc	0.046%/°C				
Nominal Operating cell Temperature(NOCT)	42±2°C				
<b>Packaging Configuration</b>					
Frame	30mm				35mm
Packing Type	40'HQ				40'HQ
Piece/Pallet	36				31
Piece/Container	740				620

\*STC:Irradiance 1000 W/m2, Environment Temperature 25°C,Air Mass AM1.5

\*NMOT:Irradiance 800 W/m2, Environment Temperature 20°C, Air Mass AM1.5



# SOLAR PANEL N-TYPE 565W~585W TP BF

Bifacial Dual Glass Mono Module

## System & Product Certificates

- IEC61215, IEC61730
- ISO9001:2015: Quality Management System
- ISO14001:2015: Environment Management System
- ISO45001:2018: Occupational health and safety management systems

## Module Structure Drawing

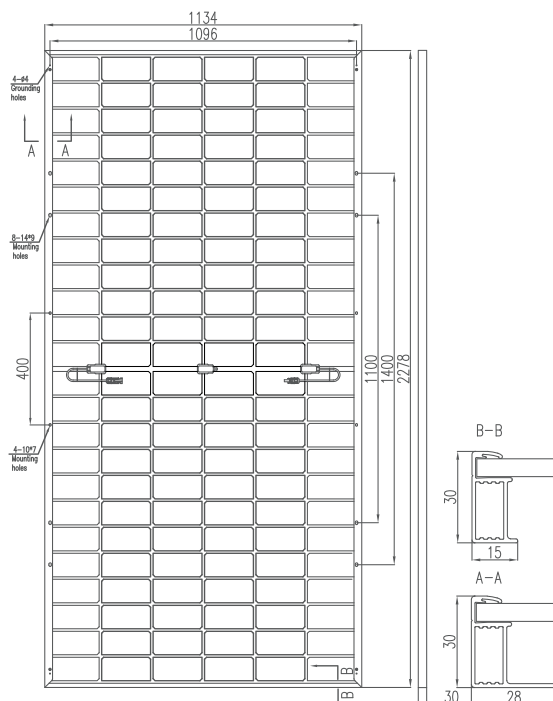

Note: 400mm hole distance is only applicable when specified by the customer

## Introduction

Introducing our N-TYPE cutting-edge solar panel: engineered for maximum power output and reliability, even in low-light conditions like cloudy days. Featuring zero Light Induced Degradation (LID) and superior temperature coefficient for consistent performance. Certified to withstand harsh environments, it's your reliable solution for sustainable energy.

## Product Features

- **10%-30% Additional Power Generation** 30 years lifespan brings 10%-30% additional power generation comparing with conventional P-type module
- **Outstanding Low Light Performance** Higher power output even under low-light environments like on cloudy or foggy days.
- **Zero LID (Light Induced Degradation)** N-type solar cell has no LID naturally which can increase power generation
- **Better Temperature Coefficient** Higher power generation under working conditions, thanks to passivating contact cell technology
- **PID Resistance** Excellent Anti-PID performance guarantee via optimized mass-production process and materials control
- **Enhanced Mechanical Load** Certified to withstand: wind load (2400 Pascal) and snow load (5400 Pascal)
- **Withstanding Harsh Environment** Reliable quality leads to a better sustainability even in harsh environment like desert, farm and coastline.
- **Lower LCOE** Higher bifaciality, higher power output and lower BOS cost
- **Wider Applicability** More application scenes like BIPV, vertical installation, snowfield, high-humid, windy and dusty area

## Performance Warranty

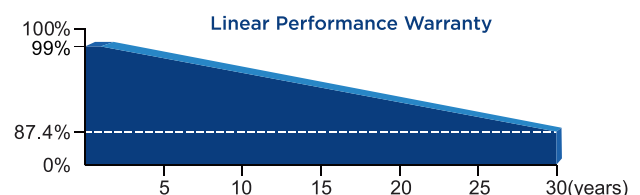

12 Years Product Warranty on Materials and Workmanship

30 Years Linear Performance Warranty

0.40% Subsequent Annual Degradation



# ES565TP BF ~ ES585TP BF N-TYPE

## Characteristic Curves(570W)

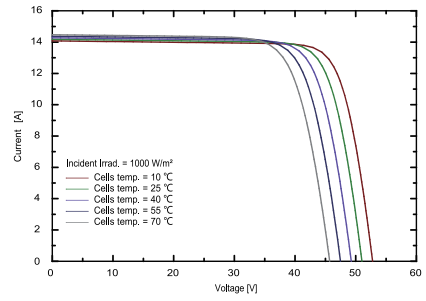
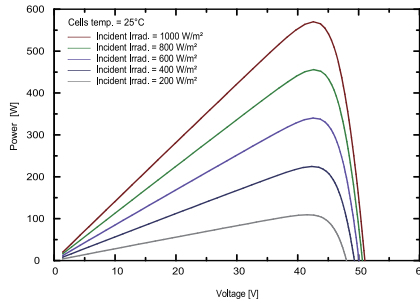
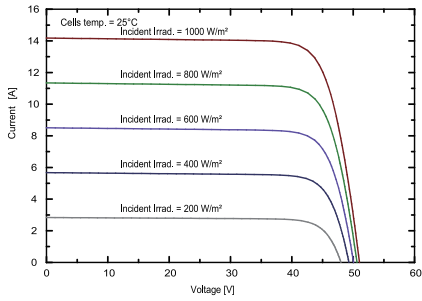

## Product Specifications

Model	ES565TP BF	ES570TP BF	ES575TP BF	ES580TP BF	ES585TP BF
<b>Electrical Properties(STC*)</b>					
Power Output(Wp)	565	570	575	580	585
Max Power Tolerance(W)	0-5	0-5	0-5	0-5	0-5
Module Efficiency(%)	21.87	22.07	22.26	22.45	22.65
Voltage Mpp-Vmpp(V)	42.35	42.51	42.69	42.87	43.02
Current Mpp-Impp(A)	13.34	13.41	13.47	13.53	13.60
Voltage Open Circuit-Voc(V)	50.83	51.03	51.23	51.43	51.63
Short Circuit Current-Isc(A)	14.12	14.18	14.24	14.30	14.36
<b>Electrical Properties(NMOT*)</b>					
Power Output(Wp)	427	431	435	439	443
Voltage Mpp-Vmpp(V)	39.79	39.98	40.13	40.28	40.44
Current Mpp-Impp(A)	10.73	10.78	10.84	10.90	10.96
Voltage Open Circuit-Voc(V)	48.45	48.64	48.83	49.02	49.21
Short Circuit Current-Isc(A)	11.40	11.45	11.49	11.54	11.59

### With Different Power Generation Gain (regarding 570W as an example)

Power Gain (%)	Power Output (Wp)	Voltage Mpp-Vmpp (V)	Current Mpp-Impp (A)	Voltage Open Circuit-Voc (%)	Short Circuit Current-Isc (A)
10	627	42.51	14.75	51.03	15.60
15	656	42.51	15.42	51.03	16.31
20	684	42.51	16.09	51.03	17.02
25	713	42.51	16.76	51.03	17.73
30	741	42.51	17.43	51.03	18.43

### Mechanical Properties

Cell Size	182mm*91mm
Number of Cells	144 [ 2 x (12x 6) ]
Module Dimension	2278*1134*30
Weight	32.5 kg
Front Glass	2.0mm, Anti-Reflection Coating
Rear Glass	2.0mm, Heat Strengthened Glass
Frame	Anodized Aluminium Alloy
Junction Box	IP68 (3 diodes)
Cable Lenth	TUV 1x4.0mm <sup>2</sup> , (+):300mm/ (-):200mm or Customized length

### Operating Properties

Operating Temperature	-40°C~+85°C
Maximum System Voltage	1500V DC (IEC)
Maximum Series Fuse Rating	30A
Power Tolerance	0~+5W
Bifaciality	80±5%

### Packaging Configuration

Frame	30mm
Packing Type	40'HQ
Piece/Pallet	36
Piece/Container	720

### Temperature Coefficient

Temperature Coefficient of Pmax	-0.310%/°C
Temperature Coefficients of Voc	-0.26%/°C
Temperature Coefficients of Isc	0.046%/°C
Nominal Operating cell Temperature(NOCT)	42±2°C

\*STC:Irradiance 1000 W/m<sup>2</sup>, Environment Temperature 25°C,Air Mass AM1.5

\*NMOT:Irradiance 800 W/m<sup>2</sup>, Environment Temperature 20°C, Air Mass AM1.5



[www.eastmanworld.com](http://www.eastmanworld.com)  
[marketing@eastmanworld.com](mailto:marketing@eastmanworld.com)

**AMPS MIDDLE EAST FZ LLC**

#703, 7<sup>TH</sup> Floor, Deira Twin Tower,  
Baniyas Square, Deira, Dubai (UAE)

**EASTMAN AUTO & POWER LTD.**

ASF Towers, 249, Udyog Vihar Phase-4, Gurugram,  
Haryana-122016, India

**GUANGDONG EASTMAN NEW ENERGY CO., LTD**

#1602, Meilan business centre, Intersection of Xixiang Avenue  
and Qianjin Second Road, Bao'an, District, Shenzhen-518102, China

Follow us on »  @eastman\_world  @EastmanWorld  @EastmanWorld